

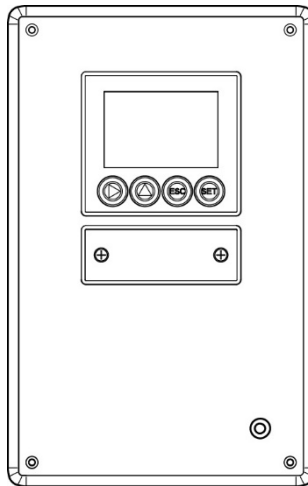

testo 6383 · differential pressure transmitter

P2A software · Parameterizing, adjusting and analyzing software

Instruction manual



1 Safety and the environment

Avoiding electrical hazards

- > Never use the instrument and connected probes to measure on or near live parts!
- > Damaged mains cables must only be replaced by authorized personnel.
- > Only have the transmitter wired and connected by authorized personnel with the voltage disconnected.
- > You must always comply with the regulations applicable in your country for opening and repairing electrical equipment.

Avoiding personal injury and damage to equipment

- > Installation, setting and calibration work must only be carried out by qualified and authorized personnel!
- > Only open the instrument when this is expressly described in the instruction manual for installation, maintenance or repair purposes.
- > Observe the permissible storage, transport and operating temperature.
- > Do not store the product together with solvents. Do not use any desiccants.
- > Do not use the instrument for control purposes at the same time as operating or servicing the transmitter.
- > Only operate the product properly, for its intended purpose and within the parameters specified in the technical data. Do not use any force.
- > Carry out only the maintenance and repair work on this instrument that is described in the documentation. Follow the prescribed steps exactly. Use only original spare parts from Testo.

Any additional work must only be carried out by authorized personnel. Otherwise testo will not accept any responsibility for the proper functioning of the instrument after repair and for the validity of certifications.



Protecting the environment

- > At the end of its useful life, send the product to the separate collection for electric and electronic devices (observe local regulations) or return the product to Testo for disposal.

2 About this document

Use

- > Please read this documentation through carefully and familiarize yourself with the product before putting it to use. Pay particular attention to the safety instructions and warning advice in order to prevent injuries and damage to the products.
- > Keep this document to hand so that you can refer to it when necessary.
- > Hand this documentation on to any subsequent users of the product.

 WARNING	Indicates potential serious injuries
 CAUTION	indicates potential minor injuries

Symbols and writing standards

Representa- tion	Explanation
i	Note: Basic or further information.
1. ... 2. ...	Action: more steps, the sequence must be followed.
> ...	Action: a step or an optional step.
- ...	Result of an action.
Menu	Elements of the program interface.
[OK]	Buttons of the program interface.
... ...	Functions/paths within a menu.
"..."	Example entries

3 Contents

1	Safety and the environment	3
2	About this document.....	4
3	Contents	5
4	Transmitter	8
4.1.	Specifications	8
4.1.1.	Functions and use.....	8
4.1.2.	Scope of delivery	8
4.1.3.	Accessories	8
4.1.4.	Technical data.....	8
4.1.5.	Dimensions	12
4.2.	Product description.....	13
4.2.1.	At a glance	13
4.2.2.	Display and keypad	14
4.2.3.	Service interface	14
4.2.4.	Relay board (option).....	14
4.2.5.	Analog outputs	15
4.2.6.	Parameters	15
4.2.7.	Scaling	15
4.2.8.	Alarm handling	16
4.3.	Commissioning.....	17
4.3.1.	Mounting preparations.....	17
4.3.2.	Connecting the instrument.....	18
4.3.2.1.	Overview of terminals.....	18
4.3.2.2.	Connecting voltage supply and analog outputs.....	19
4.3.2.3.	Connecting the relay outputs.....	20
4.3.2.4.	Connecting pressure connections	22
4.3.3.	Assembling the instrument.....	23
4.3.4.	Ethernet communication	24
4.3.4.1.	Types of operation	24
4.3.4.2.	Mains connection	24
4.3.4.3.	testo as a Saveris component.....	24
4.3.4.4.	Integration into customer's Ethernet system.....	25
4.3.5.	Adjusting the instrument.....	35
4.3.5.1.	Analog output adjustment	35
4.3.5.2.	n-point adjustment	36

4.4.	Operation	37
4.4.1.	Relationship between user menu and mini-DIN socket is active	37
4.4.2.	Password protection	37
4.4.3.	Structure of user menu	37
4.4.4.	Overview of the testo 6383 user menu	39
4.4.5.	The individual main menus	41
4.4.5.1.	Editing main menu of channel 1	41
4.4.5.2.	Editing Main Menu Alarm	41
4.4.5.3.	Editing Main Menu Settings	43
4.4.5.4.	Editing Main Menu Analysis	45
4.4.5.5.	Editing Message main menu	47
4.4.5.6.	Calling up Main Menu Ident	48
4.4.5.7.	Editing Main Menu Adjust	48
4.4.5.8.	Editing Reset main menu	49
4.5.	Status, warning and error messages	50
4.5.1.	Status messages	50
4.5.2.	Warning messages	51
4.5.3.	Transmitter error messages	52
4.5.4.	Status code in cyclical service	53
4.5.5.	Handling alarm messages	53
4.5.6.	Namur fault conditions	54
4.6.	Maintenance and cleaning	55
4.6.1.	Maintaining the instrument	55
4.6.2.	Cleaning the instrument	55
5	Parameterizing, adjusting and analyzing software (P2A software)	55
5.1.	Specifications	55
5.1.1.	Functions and use	56
5.1.2.	System requirements	56
5.1.3.	Scope of delivery	57
5.2.	First steps	57
5.2.1.	Installing the software/driver	57
5.2.1.1.	Installing P2A software	57
5.2.1.2.	Installing USB driver	57
5.2.1.3.	P2A software upgrade	58
5.2.2.	Starting the software	58
5.2.2.1.	Starting the program	58
5.2.2.2.	Establishing a connection with the instrument	58
5.2.2.3.	Activating the connection with the instrument	58

5.3.	Using the software	59
5.3.1.	User interface	59
5.3.2.	Editing instrument/parameter file	61
5.3.2.1.	Changing instrument/parameter file.....	61
5.3.2.2.	Saving parameters	69
5.3.2.3.	Opening the parameter file.....	70
5.3.2.4.	Copying and pasting parameters.....	70
5.3.2.5.	Deleting instrument/parameter file	70
5.3.2.6.	Creating a new instrument file.....	70
5.3.3.	Analyzing/testing the transmitter.....	71
5.3.3.1.	Analyzing/testing the instrument.....	71
5.3.3.2.	Carrying out factory reset	71
5.3.3.3.	Testing analog output	72
5.3.3.4.	Testing switch output relays 1 to 4	73
5.3.3.5.	Displaying min./max. values.....	74
5.3.4.	Adjusting the transmitter	75
5.3.4.1.	n-point adjustment	76
5.3.4.2.	Adjusting the analog output	77
5.3.5.	Transmitter history	78
6	Tips and assistance.....	82
6.1.	Questions and answers	82
6.2.	Accessories and spare parts	82
6.2.1.	Ordering options for testo 6383 transmitter (0555 6383).....	83

4 Transmitter

4.1. Specifications

4.1.1. Functions and use

The testo 6383 transmitter is suitable for the following applications with Ethernet networking, amongst others:

- Clean rooms
- Complex room climate applications

In addition to the signal transmission of the readings to a control unit via analog outputs, the measurement data can simultaneously be recorded, documented and visualized via Ethernet.

Furthermore, it is possible to issue an alarm for those responsible for the process, if necessary.

4.1.2. Scope of delivery

The scope of delivery of the testo 6383 transmitter includes the following:

- Sealing frame
- Instruction manual
- Calibration report

4.1.3. Accessories

The following accessories are available for the testo 6383 transmitter, amongst others:

- Mains unit
- P2A software (parameterizing, adjusting and analyzing software)
- Assembly accessories



Information about accessories and their order numbers can be found in 6.2. **Accessories and spare parts** or on the website at www.testo.com.

4.1.4. Technical data

Parameter

- Differential pressure

Accuracy



The specifications are only valid if the positive pressure is applied at the positive pressure connection.

- ± 0.3 % of measuring range, additional ± 0.3 Pa intrinsic error¹
- $T_{K \text{ slope drift}} = 0.02$ % of measuring range per degree Kelvin of deviation from nominal temperature 22 °C
- $T_{K \text{ zero point drift}} = 0$ %, as zeroing with solenoid valve²

Measuring range, resolution and overload

Measuring range depending on resolution ordered	Resolution	Overload
0 to 50 Pa	0.1 Pa	20,000 Pa
0 to 50 Pa	0.1 Pa	20,000 Pa
0 to 100 Pa	0.1 Pa	20,000 Pa
0 to 500 Pa	0.1 Pa	20,000 Pa
0 to 10 hPa	0.01 hPa	200 hPa
-10 to 10 Pa	0.1 Pa	20,000 Pa
-50 to 50 Pa	0.1 Pa	20,000 Pa
-100 to 100 Pa	0.1 Pa	20,000 Pa
-500 to 500 Pa	0.1 Pa	20,000 Pa
-10 to 10 hPa	0.01 hPa	200 hPa



Upon delivery and following a factory reset the readings are shown in the display in the unit that was ordered via the KMAT option Fxx, see 6.2.1. Ordering options for testo 6383 transmitter (0555 6383).

¹ Measuring uncertainty in accordance with GUM: ± 0.5 % of measuring range final value ± 0.3 Pa.

The determination of measurement uncertainty takes place according to GUM (Guide to the Expression of Uncertainty in Measurement): For the determination of measurement uncertainty, the accuracy of the measuring instrument (hysteresis, linearity, reproduceability), the uncertainty contribution of the test site as well as the uncertainty of the adjustment site (works calibration are taken into account. For this purpose, the value of $k=2$ of the extension factor, which is usual in measurement technology is used as a basis, which corresponds to a trust level of 95%.

² Minor mixtures of the media may occur at the positive and negative pressure side due to the automatic zeroing cycle.

Meas. cycle

- 1/sec

Interface

- Mini-DIN for P2A software (adjustment and parameterization software)
- Ethernet interface RJ45 (Ethernet 10 BatesT/100)

Voltage supply

- 4-wire (separate signal and supply lines): 20 to 30 V AC/DC, 300 mA power consumption

Maximum load

- 4-wire: 500 Ω (power output)

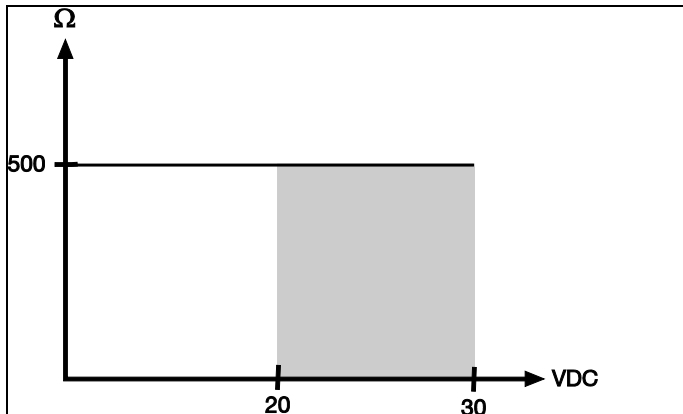

Maximal load

- 4-wire: 10 k Ω (voltage output)

Analog output

- 0 to 1 V \pm 1.5 mV (4-wire) or
- 0 to 5 V \pm 7.5 mV (4-wire) or
- 0 to 10 V \pm 15 mV (4-wire) or
- 0 to 20 mA \pm 0.03 mA (4-wire) or
- 4 to 20 mA \pm 0.03 mA (4-wire)
- $T_K = 0.05$ %K of measuring range per degree Kelvin of deviation from nominal temperature 22 $^{\circ}$ C

Resolution of analog output

- 12 bit

Relay

- 4 relays, 250 V AC/DC, 3 A (optional)

Display

- 2-line LCD with plain text line (optional)

Operating temperature

- -5 to 50 °C/23 to 122 °F

Storage temperature

- -20 to 60 °C/-4 to +140 °F

Process temperature

- -20 to 65 °C/-4 to 149 °F

Housing, weight

- Metal/plastic, approx. 0.9 kg

Protection class, frontal

- IP 65 only if the transmitter is wired, Ethernet connector is inserted and/or sealing plugs are inserted.

Directives, standards and tests

- EC Directive: 2014/30/EU

4.1.5. Dimensions

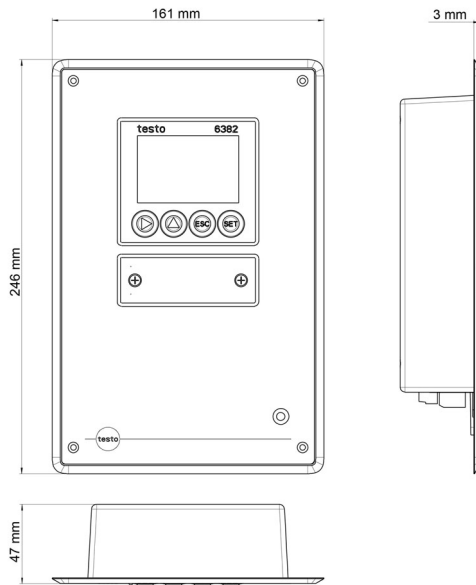

4.2. Product description

4.2.1. At a glance

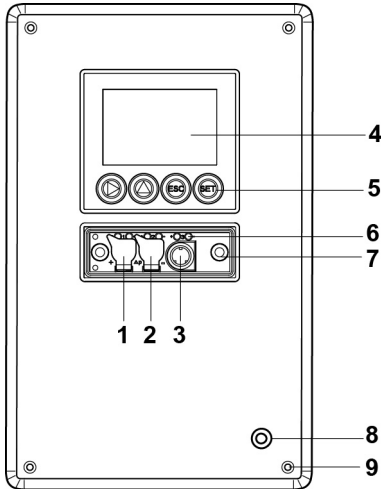

- 1 Sealing plugs on the positive pressure test connection (Ø 4 mm)
- 2 Sealing plugs on the negative pressure test connection (Ø 4 mm)
- 3 Socket for service plug
- 4 Display (optional)
- 5 Keys (only with optional display)
- 6 Test rods for the analog outputs
- 7 Service cover screw connection (self-locking, 2 pcs.)
- 8 Aperture for front pressure connection
- 9 Openings for screws for fastening to the wall

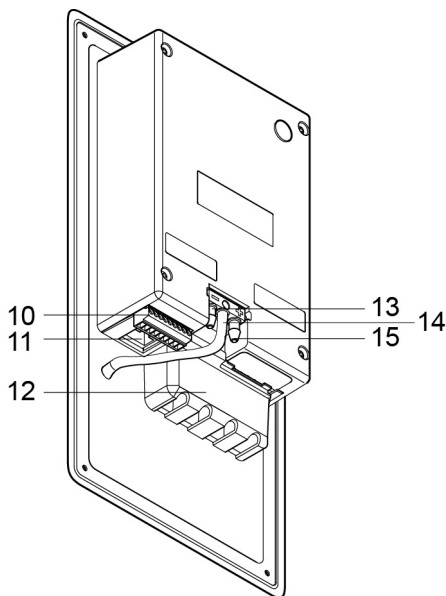

- 10 9-pin connector for the current/voltage supply
- 11 Socket for Ethernet interface
- 12 Relay cover with 12-pin connector underneath for relay connection (option)
- 13 Negative pressure connection (Ø 6.4 mm)
- 14 Blind connection as hose holder for front pressure connection hose (Ø 6.4 mm)
- 15 Positive pressure connection (Ø 6.4 mm)

4.2.2. Display and keypad

The display option allows operation of the testo 6383 transmitter via the display and four keys.

The LCD display consists of two 7-segment lines for displaying readings and units and of an information line (for status messages, for example).

The brightness and contrast of the display and the background lighting (permanent or off) can be changed via the user menu or the P2A software.

4.2.3. Service interface

The parameterizing socket (mini-DIN) is located behind the service cover as an interface to the P2A software.

4.2.4. Relay board (option)

This has a floating switch capacity of 250 V AC/3 A. The switching limits and hysteresis as well as the function as relay for the collective alarm can be set via the display or the P2A software.

Further features include:

- Function of changeover contacts (NC/NO contacts) freely selectable

- 12 terminals for a total of 4 relays.



If no relays are available, settings for monitoring limit values or alarms can still be controlled via the display. The alarm status will be shown on the display.



Only have the transmitter wired and connected by authorized personnel with the voltage disconnected.

4.2.5. Analog outputs

As analog outputs, the testo 6383 has either

- 1 current output of 0 to 20 mA (4-wire)/4 to 20 mA (4-wire) or
- 1 voltage output of 0 to 1 V/0 to 5 V/0 to 10 V (4-wire)

4.2.6. Parameters

The following parameters are displayed:

- Differential pressure in Pa, hPa, kPa, mbar, bar, mmH₂O, kg/cm², PSI, inch HG, inch H₂O

4.2.7. Scaling

There are three types of min./max. values:

- 1 The measuring range: The maximum sensor performance is in this range. Values outside of the measuring range are displayed via messages, for example. Measuring range, see table (below).
- 2 Standard scaling: The output signals are assigned to this measuring range as standard:
 - during delivery if no entries are made in the order code
 - after exchanging the unit, the measuring range recorded in the instrument is applied as standard.



The transmitter even retains its scaling with the voltage disconnected.

Measuring range, see table (below).

- 3 The maximum settings for the manual scaling
 - The maximum limits can be calculated as follows:
 $X = \text{difference between MIN. and MAX. value of the standard scaling}$
 $(\text{Max. value of standard}) + (50 \% \text{ of } X)$
 $(\text{Min. value of standard}) - (50 \% \text{ of } X)$
 - It is thus possible to scale beyond the measuring range, e.g. for the adjustment of the scaling limits to standard values of a PLC.

With the alarm definition, however, the physical measuring range limits are decisive.

Measuring range/standard scaling	Maximum scaling
0 to 50 Pa	-5 to 15 Pa
0 to 50 Pa	-25 to 75 Pa
0 to 100 Pa	-50 to 150 Pa
0 to 500 Pa	-250 to 750 Pa
0 to 10 hPa	-5 to 15 hPa
-10 to 10 Pa	-20 to 20 Pa
-50 to 50 Pa	-100 to 100 Pa
-100 to 100 Pa	-200 to 200 Pa
-500 to 500 Pa	-1000 to 1000
-10 to 10 hPa	-20 to 20 hPa

4.2.8. Alarm handling

For upper and lower alarm limits, individual alarms as well as collective alarms can be specified. If the collective alarm function is activated, an alarm is triggered as soon as the alarm limit of an alarm is exceeded, if this alarm is assigned to the collective alarm.

The testo 6383 monitors limit values with the help of relays. If a reading is outside the limit values, a relay to be specified by the user is switched.

If the reading reverts to more than a specified hysteresis below or above the limit value, the alarm is cancelled.

In addition, information about the occurrence of error/status messages can be provided by means of a collective alarm relay, see 4.5. Status, warning and error messages.



If multiple alarm messages are activated at the same time, the last alarm is shown. If the alarm is cancelled again, the previous messages are no longer shown.

4.3. Commissioning

4.3.1. Mounting preparations

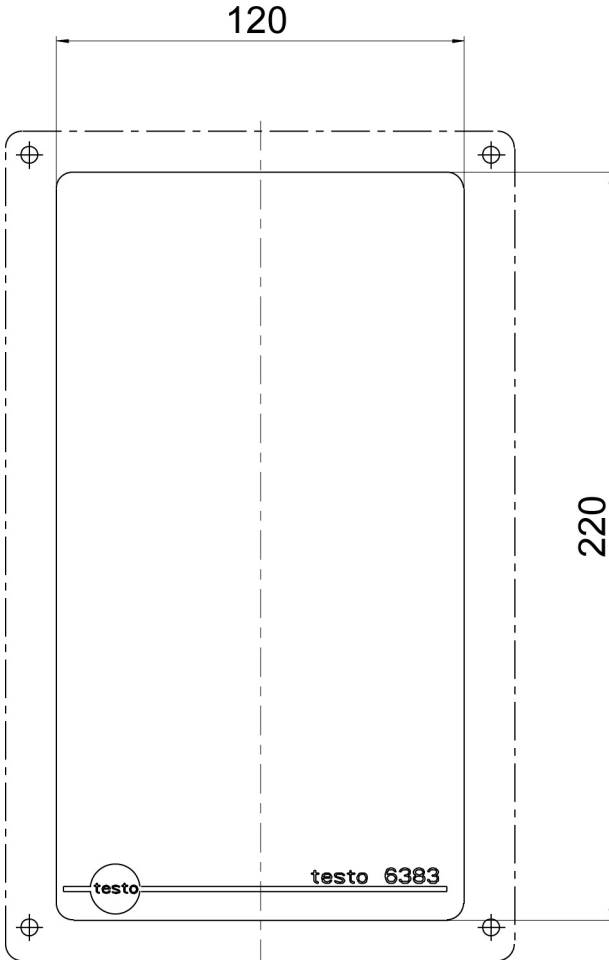

1. Create a wall opening (approx. 120 mm x 220 mm) at the mounting location.
2. Hold 6383 in assembly position and mark the drill holes.
3. Drill holes suitable for the screws to be used.
4. Connect 6383.

4.3.2. Connecting the instrument

⚠ WARNING
Electrical voltage
Danger of injury!
> De-energize the mains connection before connecting the transmitter.

i Only have the transmitter wired and connected by authorized personnel with the voltage disconnected.

4.3.2.1. Overview of terminals

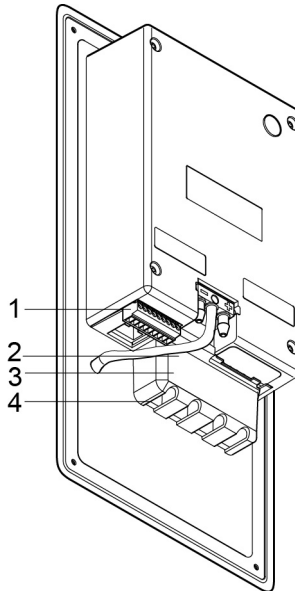

- 1 Terminal strip for voltage supply and analog outputs
- 2 Relay terminal strip (option), below the relay cover
- 3 Relay cover (option)
- 4 Insulating trough for relay board (option), below the relay cover

i The following description of the terminals refer to this overview and its numbering.

4.3.2.2. Connecting voltage supply and analog outputs

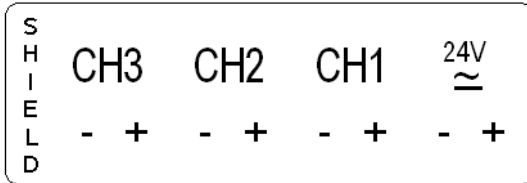

Terminal strip for voltage supply and analog outputs, item (1) of overview of terminals



Channels 2 and 3 shown on the pin assignment plan cannot be used with this instrument.

Wiring diagram for 4-wire system (0 to 20 mA/4 to 20 mA/0 to 1 V/0 to 5 V/0 to 10 V)

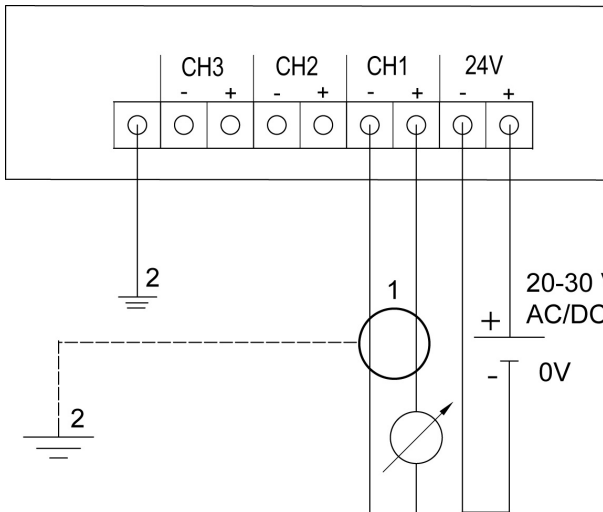

1 1 channel, 0 to 20 mA/4 to 20 mA max. load per 500 Ω 0 to 1 V/0 to 5 V/0 to 10 V

2 Functional earth



Requirement for the connecting cable of the supply:

- Shielded and insulated with cross-section of at least 0.25 mm², maximum 1.5 mm² without wire end sleeves.
- The supply line must be secured against exceeding 0.5 A.
- An OFF switch must be installed in an easily accessible position close by and be marked as such.

1. Disconnect terminal strip for voltage supply and analog outputs.
2. Strip the cable ends, clamp wire end ferrules on and screw down with voltage terminals/channel terminals.

3. Tie together each of the two adjacent cores using a cable tie.
4. Attach terminal strip for voltage supply and analog outputs.

4.3.2.3. Connecting the relay outputs

i Only have the transmitter wired and connected by authorized personnel with the voltage disconnected.

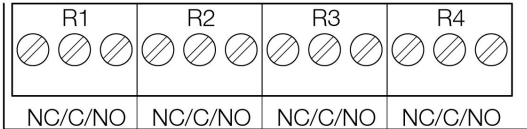

Relay terminal strip, item (2) of overview of terminals

There is the option of twelve terminals for a total of four relays.

1. Remove relay cover.
2. Disconnect relay terminal strip.
3. Strip cable ends and clamp on wire end ferrules.
4. Connect relays according to chosen function (NC/NO) (see diagrams below; relay 1 is shown as an example of a connection).

Connection note

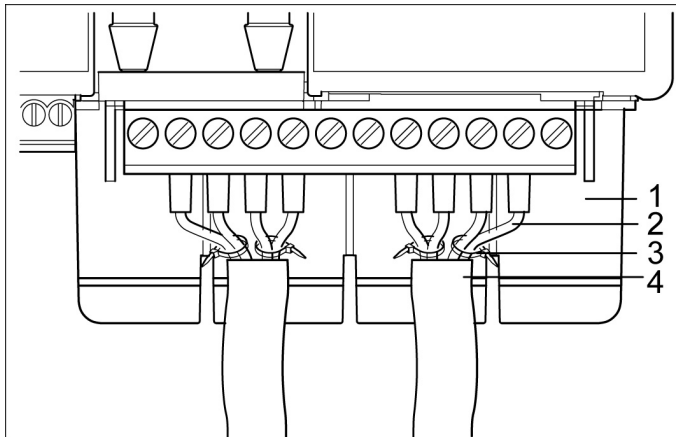

- i**
- For the connection, a double-insulated mains cable (sheathed cable) with a cross-section of at least 1.5 mm² must be used.
 - Cable connection (2) may not be routed in a loop within the relay trough (1).
 - It is recommended that you always tie 2 adjacent cores to one another using a cable tie (3).

- The insulation of the cable must be fed at least 5 mm (4) into the relay tray up to the elevated part.

Use of relay as NC contact (NC = normally closed)

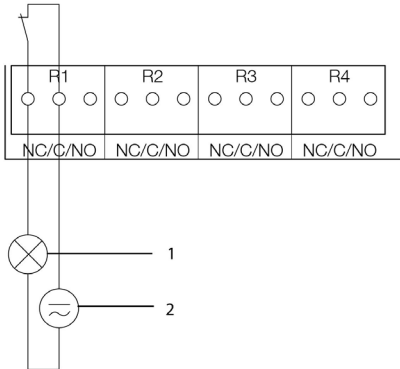

- 1 Alarm/status light (example of installation)
- 2 250 V AC/DC, 3 A

i The busy light (alarm/status light) is permanently on until the relay opens or the circuit is interrupted. This circuit can therefore be used to monitor the functionality of the alarm circuit, as a cable break, for instance, is indicated by the busy light going off.

Use of relay as NO contact (NO = normally open)

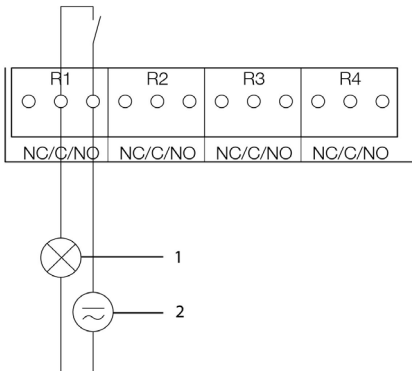

- 1 Alarm/status light (example of installation)
- 2 250 V AC/DC, 3 A

i The busy light (alarm/status light) only comes on when the relay is switched (closed). Monitoring the functionality of the alarm circuit is therefore not possible with this switching operation.

5. Insert relay terminal strip into socket.
6. Set on relay cover.

4.3.2.4. Connecting pressure connections

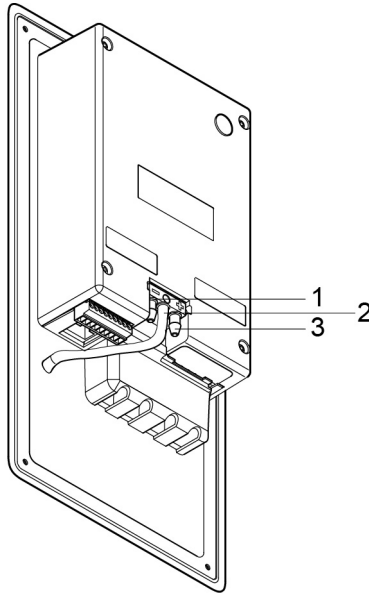

Illustration shows delivery status

Use of front pressure connection

1. Remove hose from hose holder (2) and connect to overpressure (3) or underpressure (1) connection.
2. Connect remaining pressure connection to (3) or underpressure potential (1) with additional hose.

No use of front pressure connection

i Hose connection between hose holder (2) and front pressure connection functions as a blind connection.

- > Connect pressure potentials to (3) or negative pressure connection (1) on the rear via hoses.

4.3.3. Assembling the instrument

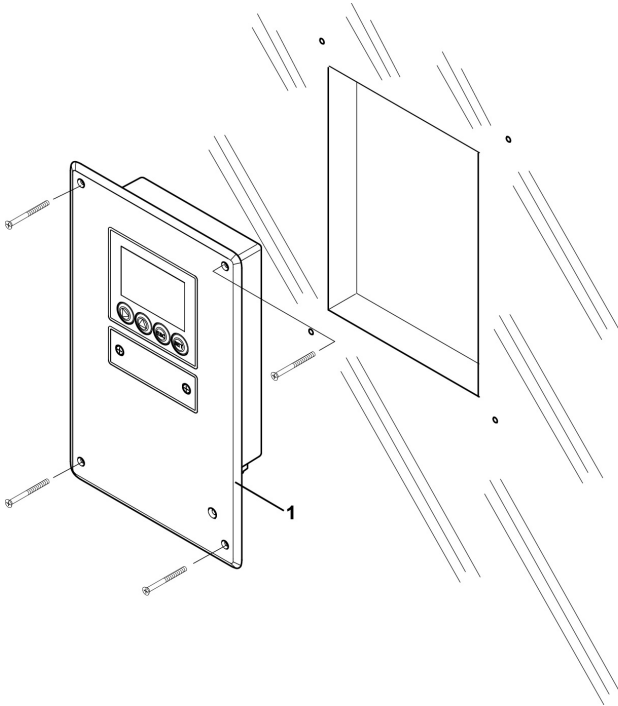

1. Slide Ethernet connector into Ethernet socket.
2. Pull sealing frame (1) over the edge of the 6383.
3. Screw on 6383. Initially, only tighten the screws slightly. When all screws are in position, also align 6383 and tighten the screws.
4. Seal 6383 using a measure appropriate for the installation point (e.g. with a silicone strip).

4.3.4. Ethernet communication

4.3.4.1. Types of operation

The type of operation can be set via the operating menu:

Settings | Ethernet | Mode |

- **Saveris Probe Mode:** a corresponding testo 6383 becomes a Saveris participant
- **XML Server Mode:** a corresponding testo 6383 can be integrated into unlimited Ethernet systems

4.3.4.2. Mains connection

> Connect the network cable to the transmitter.



The network cable must not be connected directly to the telephone network (ISDN).

4.3.4.3. testo as a Saveris component

Set IP address

- ✓ Network cable must be connected to the Ethernet interface.
- ✓ Service plug must be connected.

The IP address of the transmitter can be set either via the P2A software (transmitter accessory) or via the configuration menu of testo Saveris™ (testo Saveris™ Ethernet Assistent).

1. Set the IP address with the P2A software (see 5.3. **Using the software**) or with the testo Saveris™ Ethernet Assistent (see instruction manual).
2. Remove service plug.

Using Saveris

> Start Saveris software (see instruction manual measurement data monitoring with testo Saveris).



Ensure that the Saveris software is not already open, for example in multi-user operation in Windows® Vista. If several clients are installed in one network, ensure that when clients are operating simultaneously, they do not carry out simultaneous alterations to the configuration of the system.

1. **[Start] | All Programs | Testo |**
 - Select **Saveris Professional Client** (full version). The selection is available if Saveris Professional Client is installed.
 - Select **Saveris Viewer** (restricted functionality). The selection is available if the Saveris Viewer is installed.
 - The program window **Testo Saveris software** is opened with the dialog **Select project**.

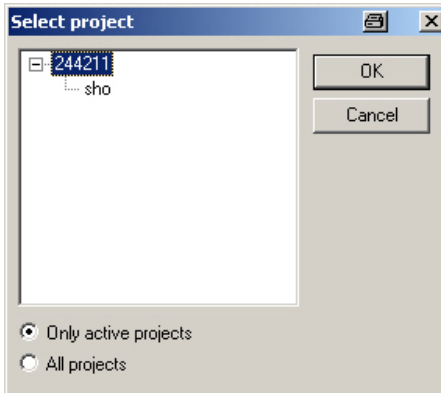

i Should the Software not start, check in the service administration of the operating system whether the service **testo tdassvcs** is started, and if necessary, restart.

2. The option
 - Select **Only active projects** when the data of a current project are to be opened.
 - Select **All projects** when the data of a closed project are to be opened.
3. Select the project to be opened from the tree structure.
4. Confirm with **[OK]**.
 - The program window **Testo Saveris software** is displayed in the foreground with the selected data set.

4.3.4.4. Integration into customer's Ethernet system

Precondition

i The user should be familiar with the structure of an XML document. Furthermore, enough knowledge should be available that this type of document can be downloaded and decoded via an Internet connection with the aid of a programming/script language.

Interface

The communication takes place according to the client/server principle, whereby the Ethernet module takes on the role of the server:

The XML interface will be approached via a URL. The URL consists of the IP address of the Ethernet module, the path for the XML document and, depending on the URL, with a clearly defined parameter. If a parameter is missing or an incorrect value is transferred, the Ethernet module sends back a simple error message.

Example:

IP address = 254.169.100.100

URL for serialnumber.xml:

`http://254.169.100.100/data/getserialnumber`

If a parameter is required, a "?" is always in the first place after the URL, then the parameter is transferred to the common query string form (name=value).

Example:

IP address = 254.169.100.100

URL for / identification.xml:

`http://254.169.100.100/config/getidentification?param=0` (compare table xml codes)

After calling up the compound URL, if everything was correct, an XML document is returned. With faulty parameters a simple HTML answer comes that points out the reason that an XML answer could not be given.

If an XML document is to be loaded on the server, access is provided by means of a POST request

Example of an upload via the program wget:

IP address = 254.169.100.100

URL for / usersettings.xml:

Path details of the folder in which the wget program is located	Command	Path details of the folder in which the usersettings XML file is located	IP address of the transmitter and required URL (see table on the next page)
H:/wget/wget-complete-stable	<code>/wget --post-file=</code>	C:/usersettings.xml	254.169.100.100/config/setusersettings

The Ethernet module supports reading out of

- Readings
- Instrument type (testo 6383)
- Firmware date and version (testo 6383)
- Status and status messages (testo 6383)

- Alarm messages (testo 6383)
 - Service hour counter (testo 6383)
- as well as the reading and writing of the:
- Adjustment data (testo 6383)
 - Configuration data of analog outputs (testo 6383)
 - Configuration data of relays (testo 6383)
 - User settings (testo 6383)

XML codes (download)

The table of xml-codes is available for download
www.testo.com/download-center (requires registration).

URL	Description	Parameter	Answer (see Appendix)
/data/getserialnumber	Read off serial number of connected transmitter		serialnumber.xml
/data/getidentification	Read off type of connected transmitter	param=0 (for transmitter)	identification.xml
/data/getversion	Read off firmware version of connected transmitter		version.xml
/data/getfirmwaredate	Read off firmware date of connected transmitter		firmwaredate.xml
/data/getonlinevalue	Read off online values of connected transmitter		onlinevalue.xml
/data/getviewchannels	Read off view channels of connected transmitter		viewchannels.xml
/data/getstatus	Read off status of connected transmitter		status.xml
/data/getlaststatusmessage	Read off last status messages of connected transmitter		laststatusmessage.xml
/config/gethourscount	Read off service hour counter of transmitter		hourscount.xml
/config/getusersettings	Read off settings of transmitter		usersettings.xml
/config/getcalibration	Read off adjustment data of transmitter	param=0 (adjustment set 1) param=1 (adjustment set 2) param=2 (adjustment set 3)	calibration.xml
/config/getreldefinition	Read off relay information of transmitter	param=0 (relay 1) param=1 (relay 2) param=2 (relay 3) param=3 (relay 4)	reldefinition.xml

4 Transmitter

URL	Description	Parameter	Answer (see Appendix)
/config/getoptions	Read off options of transmitter		options.xml
/config/getcollectivealarm	Read off alarm messages of transmitter		collectivealarm.xml

Upload XML documents

URL	Description	Parameter	Post	Answer (see Appendix)
/config/setusersettings	Perform settings of transmitter		usersettings.xml	usersettings.xml
/config/setcalibration	Set adjustment data of transmitter	param=0 (adjustment set 1) param=1 (adjustment set 2) param=2 (adjustment set 3)	calibration.xml	calibration.xml
/config/setredefinition	Set relay information of transmitter	param=0 (relay 1) param=1 (relay 2) param=2 (relay 3) param=3 (relay 4)	redefinition.xml	redefinition.xml
/config/setoptions	Set options of transmitter		options.xml	options.xml
/action/setresetm	Not yet implemented		resetm.xml	

Description of the XML elements

General elements

XML tag	Description	Type
measurement_value	Parent element. Contains the child elements value, unit, resolution	
value	Reading	Numerical, decimal number
unit	Unit	ASCII
number_values	Qty.	Numerical, whole number

Elements in calibration.xml

XML tag	Description	Type
calibration_data	Base element. Contains the child elements unit, attenuation, cal_reserved, cal_offset, cal_scale.	

XML tag	Description	Type
unit	See general elements	
attenuation	Damping (0 - 15)	Numerical, decimal number
cal_offset	Offset	Numerical, whole number
cal_scale	Parent element. Contains the child elements cal_minscale, cal_maxscale	
cal_minscale	Scaling value	Numerical, decimal number
cal_maxscale	Scaling value	Numerical, decimal number

Elements in collectivealarm.xml

XML tag	Description	Type
colalarmtable	Base element. Contains the child elements alarm_numbers, alarm	
alarm_numbers	Number of alarm messages	Numerical, whole number
alarm	Parent element. Contains the child elements alarm_event, alarm_state	
alarm_event	Type of alarm	ASCII
alarm_state	Status of the alarm 0 = alarm inactive 1 = alarm active	Numerical, whole number

Elements in firmwaredate.xml

XML tag	Description	Type
firmware_date	Base element. Contains the child elements year, month, day	
year	Year	Numerical, whole number
month	Month	Numerical, whole number
day	Day	Numerical, whole number

Elements in hourscount.xml

XML tag	Description	Type
hourcount	Base element. Contains the child element hours	
hours	Service hour counter in h	Numerical, whole number

Elements in identification.xml

XML tag	Description	Type
ident	Base element. Contains the child element device_id	

4 Transmitter

XML tag	Description	Type
device_id	Transmitter type	Numerical, whole number

Elements in laststatusmessage.xml

XML tag	Description	Type
mufmsg	Base element. Contains the child elements msg, sn, hours	
msg	Status message	ASCII
sn	Serial number	ASCII, 8 characters
hours	Service hour counter in h	Numerical, whole number

Elements in onlinevalue.xml

XML tag	Description	Type
online_values	Base element. Contains the child elements number_values, measurement_value	
number_values	See general elements	
measurement_value	See general elements	

Elements in options.xml

XML tag	Description	Type
options	Base element. Contains the child elements device_options, production_options	
device_options	See device_options description	Numerical, whole number
production_options	See production_options description	Numerical, whole number

Elements in redefinition.xml

XML tag	Description	Type
relay_data	Base element. Contains the child elements relay_channel, relay_number, relay_status, sw_point_character, sw_point_value, hysteresis_value	
relay_channel	Measurement channel linked to the relay	Numerical, whole number
relay_number	Relay number (0 to 4)	Numerical, whole number
relay_status	Status of relay 0 = off 1 = on	Numerical, whole number

XML tag	Description	Type
sw_point_charact	Switch point: Switch point: 0 = low-limit monitoring 1 = high-limit monitoring	Numerical, whole number
sw_point_value	Switch point	Numerical, decimal number
hysteresis_value	Hysteresis	Numerical, decimal number

Elements in serialnumber.xml

XML tag	Description	Type
serialnumber	Base element. Contains the child element number	
number	Serial number	ASCII, 8 characters

Elements in status.xml

XML tag	Description	Type
mufstatus	Base element. Contains the child elements statemsg, staterel, statecounter	
statemsg	Status message See statemsg description	Numerical, whole number
staterel	Status relay See staterel description	Numerical, whole number
statecounter	Counter	Numerical, whole number

Elements in usersettings.xml

XML tag	Description	Type
usersettings	Base element. Contains the child elements (pressure)*, (abs_pressure_pa_process)*, (temperature_c_process)*, (abs_pressure_pa_norm)*, (temperature_c_norm)*, (abs_pressure_pa)*, (area)*, (correction_factor)*, (pitot_factor)*, setting_display, backlight, contrast, language, disp_msg	
pressure	Absolute pressure	Numerical, decimal number

* Child elements are optional

4 Transmitter

XML tag	Description	Type
setting_display	Auto OFF background lighting 0 -> background lighting auto off 1 -> background lighting stays on	Numerical, whole number
backlight	Brightness of background lighting 0 to 9 (0 = off, 9 = max.)	Numerical, whole number
contrast	Display contrast 0 to 9 (0 = min., 9 = max.)	Numerical, whole number
language	Language 0 ->German 1 ->English 2 ->French 3 ->Spanish 4 ->Italian 5 ->Japanese 6 ->Swedish	Numerical, whole number
disp_msg	Status messages display 0 = off 1 = on	Numerical, whole number
abs_pressure_pa_process,	Pressure process data, absolute pressure in Pa	Numerical, decimal number
temperature_c_process	Pressure process data, process temperature in °C	Numerical, decimal number
abs_pressure_pa_norm	Pressure standard data, absolute pressure in Pa	Numerical, decimal number
humidity_norm	Pressure standard data, process humidity in % RH	Numerical, decimal number
temperature_c_norm	Pressure standard data, process temperature in °C	Numerical, decimal number
area	Cross-section of the duct in mm ²	Numerical, decimal number
correction_factor	Correction factor	Numerical, decimal number
pitot_factor	Pitot tube factor	Numerical, decimal number

Elements in versions.xml

XML tag	Description	Type
firmware_version	Base element. Contains the child element version	
version	Firmware version:	ASCII, 6 characters

Elements in viewchannels.xml

XML tag	Description	Type
----------------	--------------------	-------------

XML tag	Description	Type
view_channels	Base element. Contains the child elements number_values, view_channel	
number_values	See general elements	
view_channel	Parent element. Contains the child elements channel_info, measurement_value, meas_status	
channel_info	Parent element. Contains the child elements connector_info, channel_type	
measurement_value	See general elements	
meas_status	Parent element. Contains the child elements min, max, mean	
connector_info	Channel (transmitter)	ASCII
channel_type	Parameter details	ASCII
min.	Minimum reading	Numerical, decimal number
max.	Maximum reading	Numerical, decimal number
mean	Mean value	Numerical, decimal number

production_options description

Content of production_options is a double word type number (32 bit). The individual hardware options are bit-coded here.

xxxx xxxx xxxx xxxx xxx1 2222 3334

- 1 0=2-wire
1=4-wire
- 2 free
- 3 0=4 to 20 mA
1=0 to 20 mA
2=0 to 1 V
3=0 to 5 V
4=0 to 10 V
- 4 0=1 analog output

device_options description

Content of device_options is a double word type number (32 bit). The individual instrument options are bit-coded here.

xxxx xxxx xxxx xxxx xxx1 2222 2345

- 1 free
- 2 free

xxxx xxxx xxxx xxxx xxxx xxxx 1222 2345

- 3 free
- 4 0=no relay present
1=relay present
- 5 0=no display
1=display present

statemsg description

Content of statemsg is a double word type number (32 bit). The individual status messages are bit-coded here.

If statemsg = 0 there are no new messages.

If statemsg != 0

xxxx xxxx xxxx xxxx xxxx xxxx 1234 5678

- 1 free
- 2 free
- 3 free
- 4 free
- 5 free
- 6 1=transmitter information
- 7 1=transmitter warning
- 8 1=transmitter error

staterel description

Content of staterel is a double word type number (32 bit). The individual relay states are bit-coded here.

xxxx xxxx xxxx xxxx xxxx xxxx xxxx x123

- 1 0=relay 4 is not set
1=relay 4 is set
- 2 0=relay 3 is not set
1=relay 3 is set
- 3 0=relay 2 is not set
1=relay 2 is set
- 4 0=relay 1 is not set
1=relay 1 is set

More information can be found in the download area at www.testo.com.

4.3.5. Adjusting the instrument

4.3.5.1. Analog output adjustment

The purpose of adjusting the analog outputs is to adjust the signal chain from the digital signal (within the transmitter) to the analog outputs. The signal type that was appointed for the transmitter is adjusted respectively for each channel (e.g. 4 to 20 mA or 0 to 1 V, etc.).

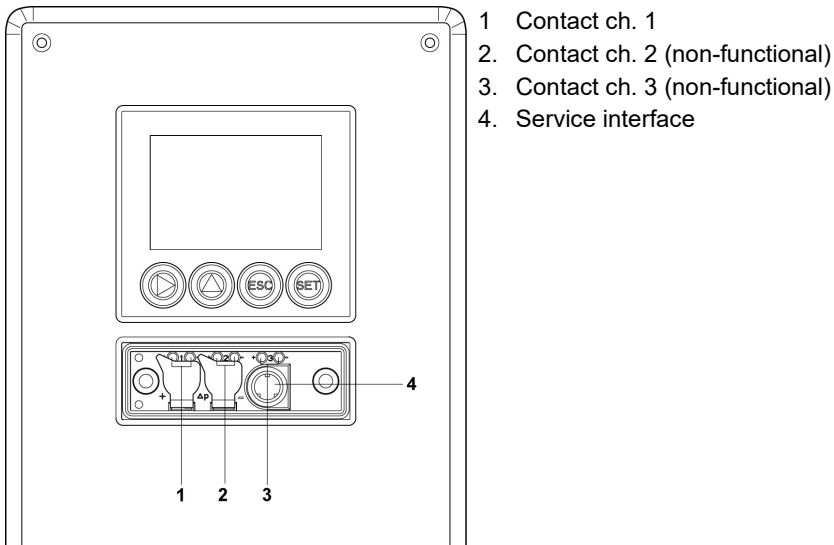

Adjusting analog output 1

- ✓ With testo 6383 with current output: Load of max. 500 Ω is connected to channel 1.
- ✓ A precise multimeter (minimum requirement: resolution 6.5 digits, at least 5-times more accurate than the 6383) is available.



If only a simple multimeter is available, the analog output must not be adjusted.

- ✓ The service cover is open.
- 1. Connect the inputs of the multimeter with the contacts (1) and (2) for channel 1.

2. Transfer the reference analog value measured with the multimeter into the P2A software (see 5.3.4.2. Adjusting the analog output, or enter it via the user menu (see 4.4.5.7. Performing analog adjustment).
3. Disconnect connections between the multimeter and the contacts of the testo 6383 and close the service cover.

4.3.5.2. n-point adjustment

With an n-point adjustment, the parameters at the 3-6 measurement points are adjusted to the reference value. The reference conditions are obtained by using a precise pressure sensor that should be 5-times more accurate than the transmitter.

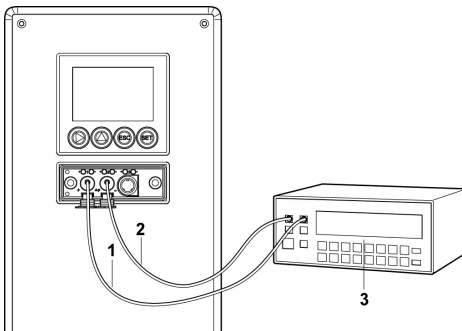

- 1 Positive pressure connection
2. Negative pressure connection
3. Pressure sensor

i The number of measuring points is set to 3 by the factory and can only be changed using the P2A software (see 5.3.4.1. **n-point adjustment**).

i The n-point adjustment must always be carried out to its full extent and in good time at all selected measurement points.

- ✓ A precise pressure sensor (5-times more accurate than the transmitter, e.g. DPC precision pressure sensor from testo industrial services) is available.
1. Connect the positive output of the pressure sensor (3) to the positive pressure connection of the transmitter (1) and the negative output of the pressure sensor (3) to the negative pressure connection of the transmitter (2).
 2. Transfer the reference pressure value created with the pressure sensor into the P2A software (see 5.3.4.1. n-point adjustment,) or enter it via the user menu (see 4.4.5.7. Performing analog adjustment).
 3. Repeat step 2 for all of the measuring points.
 4. Disconnect connections between the pressure sensor and the pressure connections of the testo 6383.

4.4. Operation

4.4.1. Relationship between user menu and mini-DIN socket is active

The testo 6383 can be parameterized using either the user menu or the P2A software (see 5. Parameterizing, adjusting and analyzing software (P2A software)).



The testo 6383 transmitter can only be operated via the display and keypad if the display option is available.

If the testo 6383 is connected to the P2A software, the user menu is blocked for the duration of the communication. The message Service plug is shown in the display of the testo 6383. As soon as the P2A software is disconnected, the user menu is accessible again.

4.4.2. Password protection

The user menu can be protected with a four-digit numerical code (see 4.4.5.3. Editing Main Menu Settings) so that access to the user menu is denied to unauthorized persons not familiar with this numerical code.

If the password protection is not to be used, the numerical code "0000" must be entered. This is also the status upon delivery.

4.4.3. Structure of user menu

At the main menu level, the user menu comprises the following:

- Main Menu Channel 1
- Main Menu Alarm
- Main Menu Settings
- Main Menu Analysis
- Main Menu Messages
- Main Menu Ident
- Main Menu Adjust
- Main Menu Reset

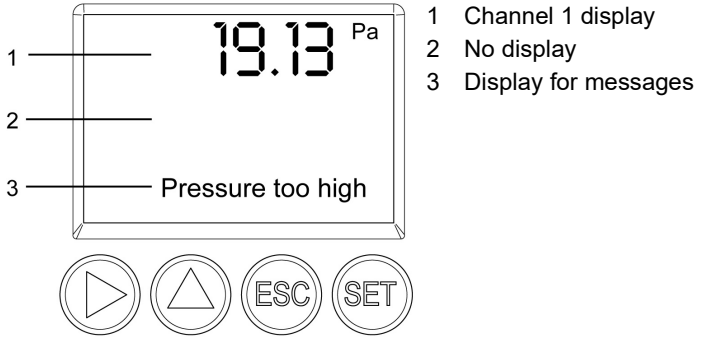

Four keys enable the user to navigate/scroll through the menus and enter/amend values and settings:

Key	Function/description
SET	<ul style="list-style-type: none"> In Measuring Mode: changes to parameterization In Parameterizing Mode: confirms a selection or setting
ESC	<ul style="list-style-type: none"> Leaves a menu (without modifying any settings)
▶	<ul style="list-style-type: none"> Selecting: scrolls through menus (downwards) or selectable alternatives Editing: changes to next digit (to the right)
▲	<ul style="list-style-type: none"> Selecting: scrolls through menus (upwards) or selectable alternatives Editing: increases the value of the current digit by 1

4.4.4. Overview of the testo 6383 user menu

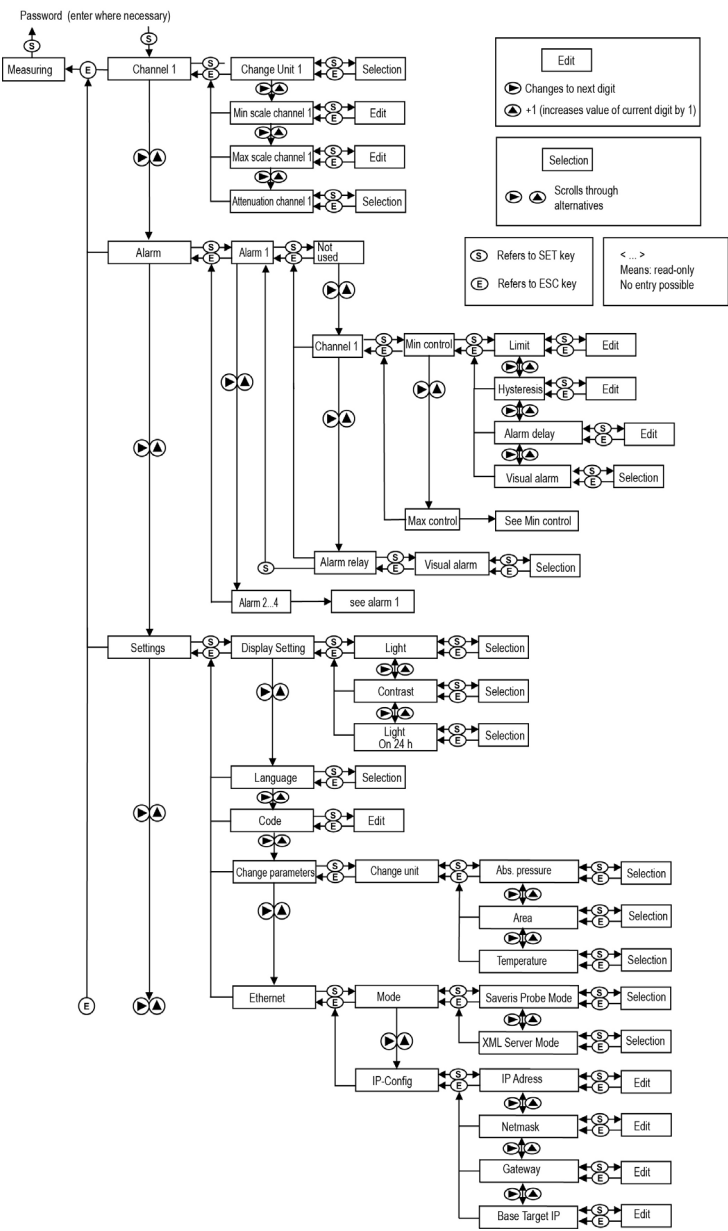

4 Transmitter

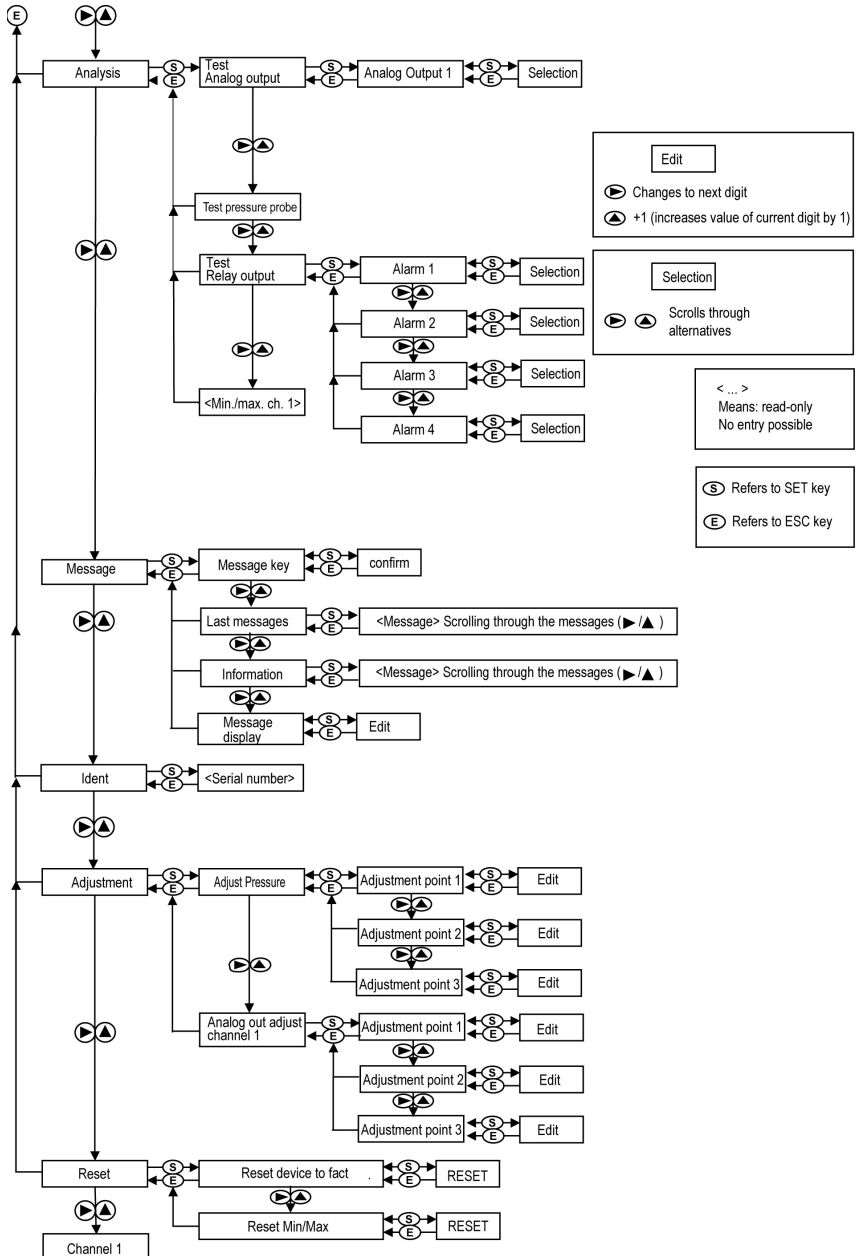

4.4.5. The individual main menus

4.4.5.1. Editing main menu of channel 1

An overview is given in 4.4.4. Overview of the testo 6383 user menu).

You can perform basic settings for channel 1.

1. In the Measuring Mode press **SET**, select **Main Menu Channel 1** with **▶** or **▲** and confirm selection with **SET**.
One of the following parameters can now be selected using **▶** or **▲**, after which the selection must be confirmed with **SET**:
 - Channel 1 Unit
The parameter for this channel is selected.
Edit/select parameter with **▶** or **▲**, confirm with **SET** or abort entry with **ESC**.
 - Scale minimum for channel 1:
The lower scale limit is edited; Unit as selected above.
Editing the value: Scroll one digit to the right using **▶** and increase value of digit by 1 using **▲**. Confirm with **SET** or abort entry with **ESC**.
 - Scale maximum for channel 1
The upper scale limit is edited;
Unit as selected above.
Editing the value: Scroll one digit to the right using **▶** and increase value of digit by 1 using **▲**. Confirm with **SET** or abort entry with **ESC**.
 - Signal delay ("Attenuation") for channel 1
The analog signal can be delayed ("Attenuation"); a time constant is selected for this (1 = no delay; 2-15 = delay in seconds)
Edit/select parameter with **▶** or **▲**, confirm with **SET** or abort entry with **ESC**.
2. Continue to the main menu with **▶** or **▲** or return to Measuring Mode with **ESC**.

4.4.5.2. Editing Main Menu Alarm

With the alarm, the relays, available as options, are programmed. In addition, the alarm statuses are shown on the display (top right) (even without relays).

You can choose whether the alarm is to be used to monitor limit values or as a collective alarm. If an alarm is to be used to monitor

limit values, you can choose between monitoring the minimum or maximum value and set a limit value and hysteresis for each alarm. In addition, every alarm can be linked to a clearly visible visual alarm (display background lighting and the corresponding measurement value flash when limit values are violated).

An alarm delay between 0 and 3600 seconds can still be assigned to every alarm used for limit value monitoring so that both the corresponding relay effect and the visual alarm are delayed. If the alarm status goes out within the set alarm delay time, neither the visual alarm nor a relay connection is triggered. .

With an alarm status present, the visual alarm and all relay outputs can be reset by means of acknowledgement with any button. The triggering of a new alarm cannot be enabled until after the alarm status goes out.

1. In the Measuring Mode press **SET**, select **Main Menu Alarm** with **▶** or **▲** and confirm selection with **SET**.
 - Four alarms can be parameterized.
2. Select **Alarm x** with **▶** or **▲** and confirm selection with **SET**.

Using alarm to monitor limit values

NO contact

Monitoring minimum

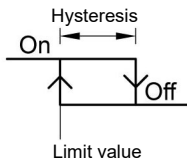

Monitoring maximum

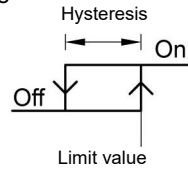

NC contact

Monitoring minimum

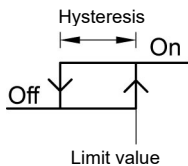

Monitoring maximum

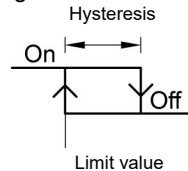

3. Select **Channel x** (e.g. "Channel 1") with **▶** or **▲** and confirm selection with **SET**.
4. Select **Max control** or **Min control** with **▶** or **▲** (see graphic).
5. Press **SET** and edit **Limit value** as well as **Hysteresis**: Scroll one digit to the right using **▶** and increase value of digit by 1 using **▲**. Confirm with **SET** or abort entry with **ESC**.

6. Select **Visual alarm** with ► or ▲. Select **YES** or **NO** with ► or ▲. Confirm with **SET** or abort entry with **ESC**.
7. Press **SET** and edit **Alarm delay**: Scroll one digit to the right using ► and increase value of digit by 1 using ▲ (0 to 3600 seconds possible). Confirm with **SET** or abort entry with **ESC**.
8. Return to **Channel x** with **ESC**.
9. Return to **Alarm x** with **ESC**.
10. Change to the other relays using ► or ▲ and perform settings in the same way.

Using alarm as collective alarm or not using it at all

If an alarm is assigned to the collective alarm, the relay is switched and a visual alarm can be issued via the display as soon as (at least) one of the warning or error messages of the testo 6383 transmitter becomes active.



The messages affecting the collective alarm can only be selected in the P2A software, see 5.3. Using the software.

- ✓ Alarm is selected (see previous steps 1 and 2).
1. Use ► or ▲ to determine whether **Alarm x** should be used as a **Collective alarm** or **not used**. Confirm selection with **SET**.
 2. If collective alarm is selected: Select **Visual alarm** with ► or ▲. Select **YES** or **NO** with ► or ▲. Confirm with **SET** and return to **Alarm x**.
 3. Change to another alarm using ► or ▲ and perform settings in the same way.
 4. Return to **Main Menu Alarm** with **ESC**.
 5. Continue to **Main Menu Settings** with ► or ▲ or return to Measuring Mode with **ESC**.

4.4.5.3. Editing Main Menu Settings

You can edit instrument settings and other settings.

- > In Measuring Mode, press **SET**, select **Main Menu Settings** using ► or ▲ and confirm selection with **SET**.

You can edit settings for:

- Display
- Language
- Change unit
 - Absolute pressure
 - Temperature
- Code

Editing display settings

You can set the brightness and contrast of the display.

1. Select **Display Settings** with ► or ▲ and confirm selection with **SET**.
2. Select **Backlight** or **Contrast** with ► or ▲ and confirm selection with **SET**.

One of the following parameters can now be selected using ► or ▲, after which the selection must be confirmed with **SET**:

- **Backlight**
The display illumination is changed.
Edit/select parameter with ► or ▲, confirm with **SET** or cancel entry with **ESC** (the effect of the change in parameter can be seen during input).
 - **Contrast**
The brightness difference between the display background and the displayed values is changed.
Edit/select parameter with ► or ▲, confirm with **SET** or cancel entry with **ESC** (the effect of the change in parameter can be seen during input).
 - **Backlight 24h on**
Select **On** or **Off** using ► or ▲ and confirm with **SET**.
Off: The display light switches off automatically if no button was pressed for 10 seconds.
On: The display light is activated
3. Return to **Display Settings** with **ESC** and use ► or ▲ to continue to **Language**.

Selecting language

You can select the language for the plain text line in the display.

- > Press **SET**, select required language with ► or ▲, confirm selection with **SET** and return to **Language**.



Only choose a language that you can understand well.

Editing code settings

You can set the access code (password).



If a code other than "0000" (factory setting) is set, the transmitter can only be operated once this code has been entered via the menu.

1. Select **Code** with ► or ▲ and confirm selection with **SET**.
2. Scroll one digit to the right using ► and increase value of digit by 1 using ▲. Confirm with **SET** or abort entry with **ESC**.

- Return to **Code** with **ESC** and use **▶** or **▲** to continue to **Change parameters**.

Select unit (Change unit)

This setting affects the displayed unit of all readings.

- Press **SET**, select **Change parameters** with **▶** or **▲**, confirm selection with **SET** or cancel with **ESC**.
- Select **Change unit** with **▶** or **▲**, confirm selection with **SET** or cancel with **ESC**.
- Select the required variable (absolute pressure/temperature) with **▶** or **▲**, confirm selection with **SET** or cancel with **ESC**.
- Select the required unit with **▶** or **▲**, confirm selection with **SET** or cancel with **ESC**.
- Return to **Change unit** with **ESC**.
- Return to **Change parameters** with **ESC**.
- Return to **Main Menu Settings** with **ESC**.

Setting Ethernet

Further information is available under 4.3.4. Ethernet communication.

4.4.5.4. Editing Main Menu Analysis

You can test the functionality of analog and relay outputs. In addition, you can read off the minimum and maximum values (since the last voltage supply or reset of the min./max. values).

Testing functionality of analog outputs



This function affects the analog outputs directly, not only the test contacts.

- In the Measuring Mode press **SET**, select **Main Menu Analysis** with **▶** or **▲** and confirm selection with **SET**.
 - **Test Analog Output** is shown.
- Press **SET**, scroll one digit to the right using **▶** and increase value of digit by 1 using **▲**. Any analog output value can be predefined, e.g. for an analog output of 4 to 20 mA, the value "6.0 mA". Confirm with **SET** or abort entry with **ESC**.
- Accept setting by pressing **SET** and test with multimeter (minimum requirement: resolution 6.5 digits, at least 2-times more accurate than the 6383) as follows:
Analog output 1: Via test contacts under service flap, see diagram.

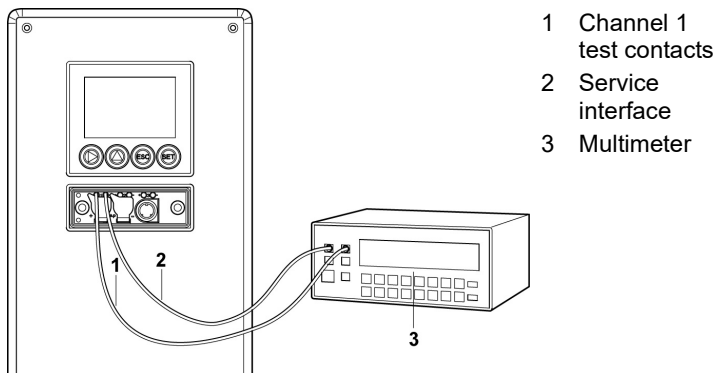

4. Return to **Test Analog Output** with **ESC** and use **▶** or **▲** to continue to **Test Relay Output**.

Testing functionality of the pressure sensor (Test pressure sensor)



This function is only required to calibrate the pressure sensor.

Testing functionality of relay outputs

1. Press **SET** and choose between **Alarm 1, 2, 3, 4** with **▶** or **▲**.
2. Press **SET**.
The relay can now be tested. You can choose between **OFF** and **ON** using **▶** or **▲**. If **ON** is chosen, the NO contact is closed, the NC contact opened. If **OFF** is chosen, the NC contact is closed, the NO contact opened.
3. To test, route a measuring cable from the relay terminals (see 4.3.2.3. Connecting the relay outputs) out of the transmitter to a multimeter (resistance measurement) or continuity tester.
4. Return to **Test Relay Output** with **SET** (starts relay test) or **ESC** (exits the menu without relay test).

Reading off min./max. values of channels

To reset the max./min. values, see 4.4.5.8. Editing Reset main menu.

1. Read off the min./max. values of the channel in succession with **▶** or **▲** and return to the **Main Menu Analysis** with **ESC**.
2. Continue to **Main Menu Message** with **▶** or **▲** or return to Measuring Mode with **ESC**.

4.4.5.5. Editing Message main menu

Messages can be confirmed/acknowledged, the last messages can be called up and the display of the messages can be switched on or off.

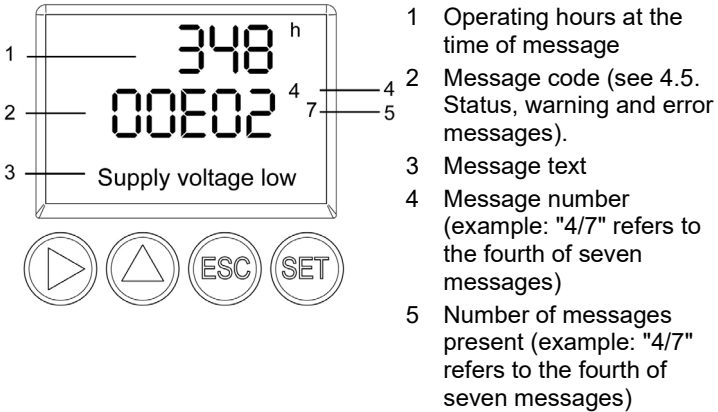

i Using the P2A software (see 5. Parameterizing, adjusting and analyzing software (P2A software)) you can predefine whether messages are to be shown in the display.

1. In the Measuring Mode press **SET**, select **Main Menu Message** with **▶** or **▲** and confirm selection with **SET**.
2. Confirm **Confirm message** using **SET**.
3. Select **Last messages** with **▶** or **▲** and confirm with **SET**.
4. Scroll between the warning and error messages recorded so far using **▶** or **▲** and return to **Last messages** using **ESC**.
5. Select **Information** with **▶** or **▲** and confirm with **SET**.
6. Scroll between the status messages recorded so far using **▶** or **▲** and return to **Information** using **ESC**.
7. Continue to **Display of message** with **▶** or **▲**.
ON: Measurements are shown on the display in Measuring Mode.
OFF: No messages shown on display.
8. Select **ON** or **OFF** with **▶** or **▲** and confirm selection with **SET**.
9. Return to **Main Menu Message** with **ESC**.

- Continue to **Main Menu Ident** with **▶** or **▲** or return to Measuring Mode with **ESC**.

i An overview of the messages can be found in 4.5. Status, warning and error messages.

4.4.5.6. Calling up Main Menu Ident

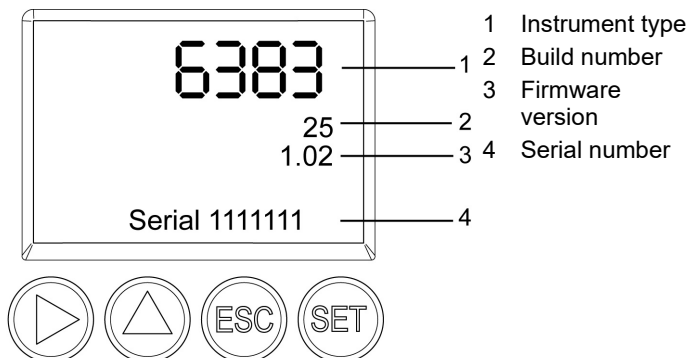

- In the Measuring Mode press **SET**, select **Main Menu Ident** with **▶** or **▲** and confirm selection with **SET**.
- The type, firmware version, build number and serial number of the transmitter are displayed.

i This information is required when servicing.

- Return to **Main Menu Ident** with **ESC**.
- Continue to **Main Menu Adjust** with **▶** or **▲** or return to Measuring Mode with **ESC**.

4.4.5.7. Editing Main Menu Adjust

For instructions on how to perform the analog adjustment see 4.3.5.1. Analog output adjustment.

Performing analog adjustment

- In the Measuring Mode press **SET**, select main menu **Adjust** with **▶** or **▲** and confirm selection with **SET**.

i Each channel is adjusted at three points in the analog range (at 10 %; 50 %; 90% of the analog scale).

- Select **Analog Adj. Ch. 1** with **▶** or **▲** and confirm with **SET**.
- Use **▶** or **▲** to select **Adj. Point 1**.

4. Press **SET**. Read off multimeter display and enter this value in the user menu. Do this by scrolling one digit to the right using **▶** and increasing the value of digit by 1 using **▲**. Confirm with **SET** or abort entry with **ESC**.
5. Use **▶** or **▲** to select **Adj. Point 2**.
6. Press **SET**. Read off multimeter display and enter this value in the user menu. Do this by scrolling one digit to the right using **▶** and increasing the value of digit by 1 using **▲**. Confirm with **SET** or abort entry with **ESC**.
7. Use **▶** or **▲** to select **Adj. Point 3**.
8. Press **SET**. Read off multimeter display and enter this value in the user menu. Do this by scrolling one digit to the right using **▲** and increasing the value of digit by 1 using **▶**. Confirm with **SET** or abort entry with **ESC**.
9. Return to main menu **Adjust** with **ESC**.
10. Continue to main menu **Reset** with **▶** or **▲** or return to Measuring Mode with **ESC**.

Performing the pressure adjustment

Also see 4.3.5.2. n-point adjustment, for instructions on how to perform the pressure adjustment.

1. In the Measuring Mode press **SET**, select main menu **Adjust** with **▶** or **▲** and confirm selection with **SET**.



The pressure adjustment can be performed at 3 to 6 adjustment points.

2. Select **Adjust Pressure** with **▶** or **▲** and confirm with **SET**.
3. Use **▶** or **▲** to select **Adj. Point 1**.
4. Press **SET**. Read off pressure sensor display and enter this value in the user menu. Do this by scrolling one digit to the right using **▶** and increasing the value of digit by 1 using **▲**. Confirm with **SET** or abort entry with **ESC**.
5. Repeat steps 1 to 4 for adjustment points 2 to 6.
6. Return to main menu **Adjust** with **ESC**.
7. Continue to main menu **Reset** with **▶** or **▲** or return to Measuring Mode with **ESC**.

4.4.5.8. Editing Reset main menu

You can reset the factory settings for the following:

- Instrument
- Min./max. values



Resetting to the factory settings means resetting to the order specification, i.e. the specific condition at the time of

supply to the customer.

1. In the Measuring Mode press **SET**, select **Main Menu Reset** with **▶** or **▲** and confirm selection with **SET**.
 - **Reset Device** to factory settings is displayed.
2. Select the setting to be reset using **▶** or **▲** and confirm selection with **SET**.
 - **Reset Completed** is displayed.
3. Return to the reset setting with **ESC** or **SET** and return to **Main Menu Reset** with **ESC**.
4. Continue to the **Main Menu Channel 1** with **▶** or **▲** or return to Measuring Mode with **ESC**.

4.5. Status, warning and error messages

To achieve optimum operational reliability (machine availability), the transmitter shows the following via the user menu or the P2A software

- Status messages
- Warning messages
- Error messages

in each case for the testo 6383 transmitter.

All messages are stored in the transmitter with an operating hours stamp. Use the user menu (see 4.4.5.5. Editing Message main menu) or the P2A software (see 5.3.5. Transmitter history) to view the message history.

In the transmitter, the last 60 status messages and the last 120 error and warning messages are stored in a ring memory. There is no limit in the P2A software.

4.5.1. Status messages

Status messages show the current operating status of the testo 6383.

Message	Display	Description
02506	Sensor initialization	Message appears while the transmitter is starting up. If the message disappears, the transmitter is ready for operation.

Message	Display	Description
01D19	Service plug	The Mini-DIN socket is connected to: the USB adapter for P2A software, the adjustment adapter or the service plug (is not recorded/no number)
00300	New limit value	The limit value has been changed or shifted
00301	Scaling changed	The scaling has been changed
00117	Adjustment DeltaP	An n-point adjustment was performed.
02104	Analog adjustment	An analog adjustment has been made
00530	Change solenoid valve	The solenoid valve should be changed
00500	Transmitter reset	The transmitter was reset to the factory settings and is restarted.
0052F	Reset Min/Max	Resets all saved Min/Max values for all channels
00503	Reset device to fact	A factory reset of the transmitter was performed
00307	User Setting Change	User Setting Change: General settings were changed for the transmitter.

4.5.2. Warning messages

Warning messages show an early warning or a current malfunction which may negatively impact measuring.

Message	Display	Cause	Remedying of fault
00E00	T ambient high	The ambient temperature exceeds the permissible temperature for the transmitter	Take necessary measures to lower ambient temperature, e.g. through venting or cooling
00E01	T ambient low	The ambient temperature is below the permissible temperature for the transmitter	Take necessary measures to raise ambient temperature, e.g. through heating

Message	Display	Cause	Remedying of fault
00809	Pressure too high	The process pressure exceeds the pressure intended for the transmitter	Remove the transmitter from the process and take any necessary measures to lower the pressure
00E02/00E05	Supply voltage low	The supply voltage is below the minimum voltage required for the transmitter	Take measures to ensure sufficient voltage supply
0081C	Alarm 1	Depending on the parameterization of the relay	Depending on the parameterization of the relay
0081D	Alarm 2	Depending on the parameterization of the relay	Depending on the parameterization of the relay
0081E	Alarm 3	Depending on the parameterization of the relay	Depending on the parameterization of the relay
0081F	Alarm 4	Depending on the parameterization of the relay	Depending on the parameterization of the relay

4.5.3. Transmitter error messages

Error messages show a current malfunction.

Message	Display	Cause	Remedying of fault
01505	Watchdog error	Due to a processor error, the transmitter performs an automatic restart.	If the problem occurs frequently, contact Testo Service.
01115	Low adjustment temperature	The ambient temperature is too low during the pressure adjustment.	Take necessary measures to raise ambient temperature, e.g. through heating.
01116	High adjustment temperature	The ambient temperature is too high during the pressure adjustment.	Take necessary measures to lower ambient temperature, e.g. through venting.

4.5.4. Status code in cyclical service

Status codes for error messages

Message in hex notation	Description	Cause
0x0C	Transmitter error	<ul style="list-style-type: none"> • Supply voltage too low • Ambient temperature too high • Ambient temperature too low • Restart of the transmitter is being performed.

4.5.5. Handling alarm messages

Shown on the display ⁴	Can be used for collective alarm ⁵	Additional message end ⁶
New limit value	x	
Scaling changed	x	
Adjustment DeltaP	x	
Pressure too high	x	x
Alarm 1		x
Alarm 2		x
Alarm 3		x
Alarm 4		x
Transmitter reset	x	
Analog adjustment	x	

⁴ If multiple messages/alarms are activated at the same time, only the last message/alarm is shown. If this is cancelled, the other messages that are still active are no longer displayed.

⁵ The message can be assigned the collective alarm function, which means that the collective alarm is activated as soon as at least one of the messages assigned to it is activated. The collective alarm can be assigned to each of the 4 optional relays. The collective alarm is then always the same, as it can only be defined once.

⁶ The message is shown upon the occurrence of the event causing the message as well as when closing. Two entries appear in the history in the P2A software: Message text_start and Message text_end.

Shown on the display ⁴	Can be used for collective alarm ⁵	Additional message end ⁶
T ambient high	x	x
T ambient low	x	x
Supply voltage low	x	x
Watchdog error	x	

Perform the **Confirm message** function (acknowledgement of the alarm via the control keys on the transmitter):

- The message/alarm is no longer shown on the display and the optical alarm goes out, where applicable. If multiple messages/alarms are active at the same time, all are reset simultaneously.
- If at least one message is assigned to the collective alarm, the collective alarm is reset. If the collective alarm is set on a relay, the relay is also reset, meaning switched to its neutral position.

4.5.6. Namur fault conditions

If the faults named in the following table occur, the analog outputs output special values that enable a general fault warning in the higher-level control system. The values correspond to the "Namur" industry standard.

Status message in the display	Class	Display value in the display	Analog output				
			0 to 20 mA	4 to 20 mA	1 V	5 V	10 V
Watchdog error	Error	Previous value stops	21 mA	3.8 mA	1.1 V	5.5 V	11 V
Value below min. scale	Underrange	Reading	0 mA	3.8 mA	0 V	0 V	0 V
Value above max. scale	Overrange	Reading	20.5 mA	20.5 mA	1.1 V	5.5 V	11 V
Pressure too high	Overrange	ooooo ·	20.5 mA	20.5 mA	1.1 V	5.5 V	11 V

4.6. Maintenance and cleaning

4.6.1. Maintaining the instrument

We recommend that the adjustment and settings of the transmitter be checked at regular intervals using the

- User menu (4.4. Operation) or
- P2A software (5. Parameterizing, adjusting and analyzing software (P2A software))

Convenient "remote monitoring" of the transmitter can be implemented, for example by using a relay as a collective alarm (see 4.4.5.2. Editing Main Menu Alarm) whose messages are forwarded to a local alarm transmitter (horn, light) or PLC.

4.6.2. Cleaning the instrument

Instrument surface

- Clean the surface of the instrument with mild cleaning agents (e.g. washing-up liquid) and water. Only use gentle and standard cleaners.
- Do not use any aggressive or chafing cleaning agents such as thinner, liquid scouring agent, wax, benzine, concentrated acids and lyes.
- Carefully rub down the instrument surface with a moist and soft cloth.

5 Parameterizing, adjusting and analyzing software (P2A software)

5.1. Specifications

The P2A software is used for the parameterizing, adjustment and analysis of testo transmitters. The following applies:

- Generally, all newer testo transmitters (as of 2007) are supported.
- For each newly purchased Testo transmitter, a free software upgrade must be installed, containing the instrument drivers for all transmitters which are connectable at that time.
- This upgrade can be downloaded free of charge at any time from the Testo homepage www.testo.com/download-center (requires registration).

The software must only be bought one time, even for owners of several testo transmitters.

5.1.1. Functions and use

In the P2A software, two different file types are used: The instrument and the parameter file.

Instrument file

The parameters of a particular transmitter are stored in its so-called instrument file. Using this file, the parameters can be edited and the instrument can be tested and adjusted.

Instrument files also contain the respective histories in addition to the parameter data, i.e. "log books" are kept for the previous parameterizations, adjustments and messages (see 5.3.5. Transmitter history).



Instrument files are ".cfm" format files.

Parameter file

Parameter files are not tied to a specific individual transmitter and contain only parameter data/no history data.

If you use various instruments of the same type, you can create parameter files once (e.g. by saving the appropriate instrument file as the parameter file) and transmit these onto the other instruments.



Parameter files are ".cfp" format files.

5.1.2. System requirements

Operating system

- Windows® 7
- Windows® 8
- Windows® 10

Computer

The computer must fulfil the requirements of the respective operating system. The following requirements must additionally be fulfilled:

- Interface USB 1.1 or higher
- Graphic resolution min. 1024 x 768



Date and time settings are automatically taken over from the computer. The administrator must ensure that the

system time is regularly synchronized with a reliable time source, in order to guarantee the authenticity of the data.

Software

The P2A software must be purchased and installed separately from the transmitter. If it is a new software version, the transmitter is already supported completely. Older P2A software versions can be updated via the P2A software upgrade.

5.1.3. Scope of delivery

Included in the scope of delivery are:

- P2A software
- USB driver



When working with the parameterizing, adjusting and analyzing software (P2A software), previous knowledge of Windows® operating systems is assumed.

5.2. First steps

5.2.1. Installing the software/driver



Administrator rights are required for installation.

5.2.1.1. Installing P2A software



Without the input of a licence key, the software will run only as a demo version (time limit 30 days).

1. You can download the software under the following link: <https://www.testo.com/download-center>. If the installation program does not start automatically: > Open download folder and start P2A.exe.
2. Follow the instructions of the installation wizard.
3. Click on [Finish] to complete the software installation.

5.2.1.2. Installing USB driver

1. You can download the USB driver under the following link: <https://www.testo.com/download-center> (Testo USB driver) If the installation program does not start automatically: > Open download folder and start USBDriver.exe.
2. Follow the instructions of the installation wizard.
3. Click on [Finish] to complete the software installation.

5.2.1.3. P2A software upgrade

1. Download and store P2A software upgrade from www.testo.com/download-center (requires registration).
2. Select folder into which the downloaded Zip file was stored, and unzip the file.
3. Start file **P2A upgrade.exe**.
4. Follow instructions from installation assistant.

5.2.2. Starting the software

5.2.2.1. Starting the program

- > Click on **All Programs** (Windows® 7, Windows® 8, Windows® 10) | **Testo** | **P2A- Software**.

i In Windows 7 the window **User account control** is opened when starting the software the first time.
> Click on **Accept**.

- The program window is opened (see 5.3.1. User interface).

5.2.2.2. Establishing a connection with the instrument

i The instrument works with limited functionality, if it is only supplied via the service plug. Some settings, which can be parameterized in the P2A software, will only be executed by the instrument, after it has been connected to the electric power supply.

Multiple instruments can be attached, however only one connection is active at all times.

- ✓ USB driver is installed (see 5.2.1.2. Installing USB driver).

1. Start the P2A software.
 2. Connect adapter (supplied with the P2A software) to the service interface of the instrument (see 4.2.3. Service interface).
 3. Connect instrument/adapter to the PC via the USB interface.
- The instrument file of the attached instrument is shown in the file list.

5.2.2.3. Activating the connection with the instrument

- > Click on the desired instrument file.
- The selected file is marked in colour and the connection with the instrument is activated.

If a connection with the instrument is established when the program is started, the corresponding instrument file is marked automatically.

5.3. Using the software

5.3.1. User interface

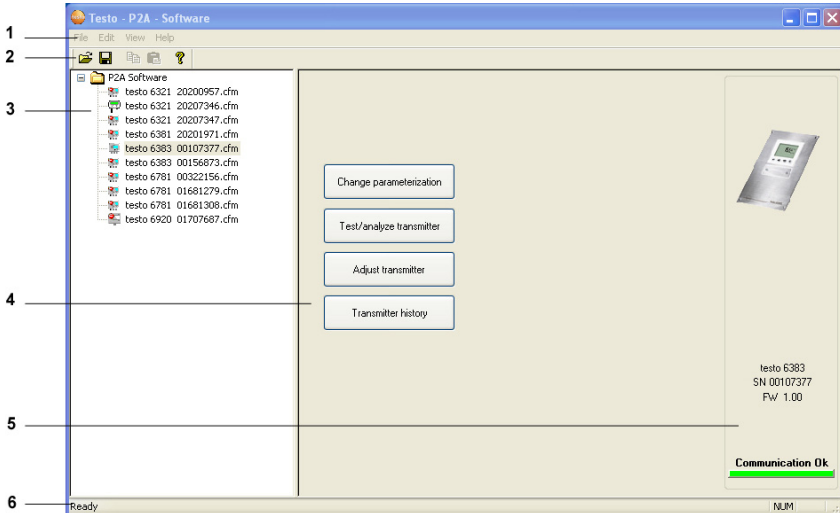



1 Menu bar:

Menu	Command	Explanation
File	Open	Shows the Windows dialogue for searching and opening files.
	Save as	Saves the parameters of an instrument or parameter file under a new name.
Edit	Copy	Copies the parameters of the marked instrument or parameter file in the cache.
	Paste	Pastes the parameters from the cache in the marked instrument or parameter file.
View	Toolbar Status bar	Activates/deactivates the toolbar or status bar.

Menu	Command	Explanation
?	Check instrument connections	Checks the connections to a connected instrument without the instrument having to be activated.
	Service	A text file with the most important information on the computer and the software is opened via Display service data .
	Information	Shows the version number of the P2A software.

2 Toolbar: Shows the Windows-compliant icons for editing.

3 File:

Icon	File	Explanation
 Symbol shows a transmitter	Instrument file	Instrument file Connection to the instrument has been established. <Type> <Serial number>.cfm File name should not be changed.
 Symbol shows a transmitter with a red minus sign in the upper left corner	Instrument file	Instrument file Connection to the instrument has not been established.
 Symbol shows a transmitter with a white P for parameter file in the upper left corner	Parameter file	<Type> <Serial number> <Date> <Time>.cfp File name can be changed. The name can be selected freely, but it is recommended that you retain the reference to the instrument. Parameter files are always marked red; the parameter values they contain are only forwarded to the instrument after being transmitted to the instrument file.

4 Function buttons: Dialogues on editing and testing the instrument are opened by means of the buttons.

[Change parameterization] see 5.3.2.1. Changing instrument/parameter file.

[Test/analyze transmitter] see 5.3.3.1. Chapter Analyzing/testing the transmitter.

[Adjusting the transmitter] see 5.3.4. Chapter Adjusting the transmitter.

[Transmitter history] see 5.3.5. Transmitter history.

5 File information:

Status	Shown in the window
An instrument file is selected	Type, serial number, firmware version of the instrument.
A parameter file is selected	Type, serial number and firmware version of instrument for which the parameter file was created.
Connection status	Green = connection is active Red = connection is inactive

6 Status bar: Shows the current status when editing via the menu bar.

5.3.2. Editing instrument/parameter file

5.3.2.1. Changing instrument/parameter file

✓ The desired instrument/parameter file is marked.

1. Click on **[Change parameterization]**.

- The **Properties of <Instrument type> <Serial number>** dialogue is opened with the **Change parameterization** register.

If the parameters were transmitted from other parameter files into the instrument file, a message is shown with which you can transmit the new parameters to the connected instrument using **[Yes]**.

> If the parameters should not be transmitted, click on **[No]**.

2. Change or enter parameters in the corresponding fields.

Field	Explanation
Unit/ Analog output	All analog outputs are parameterized in this mask.

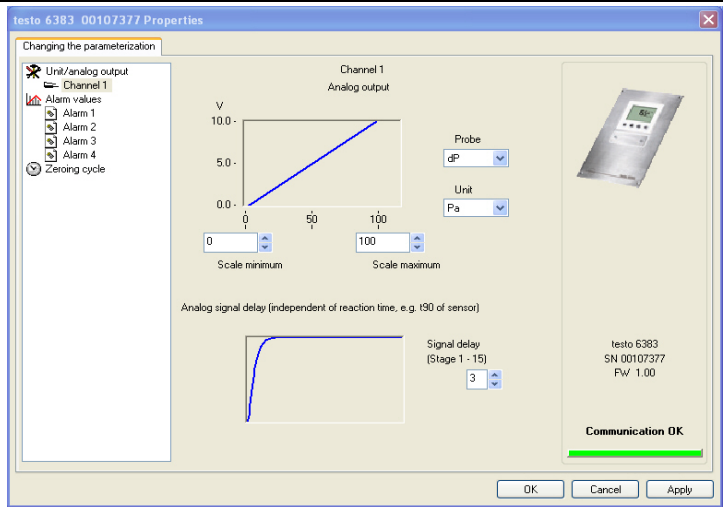

Unit/analog output (graphic)	Unit: 0 to 1 V/5 V/10 V or 0 to 20 mA/4 to 20 mA. Vertical: Current version of the analog output (cannot be changed). Horizontal: Min./max. scale end points of selected unit. The curve changes in accordance with the entered value of scale minimum and maximum.
------------------------------	--

Scale minimum/ maximum	The endpoints of the scaling can be selected up to the stored scale minimum and maximum. In the process, scaling can take place beyond the measuring range in order to adjust the analog output to the customer system, see 4.2.7. Scaling.
---------------------------	---

Field	Explanation
Unit	Selection of the physical unit. When changing the unit, standard values are set for scale minimum and maximum. Caution! When changing the phys. unit, the relay limit values are set to the assigned default values.
Signal delay (graphic)	Curve changes according to the set signal delay.
Signal delay	Time interval in stages 1 – 15: 1 = no delay 15 = longest delay. The signal delay is added to the reaction time of the sensor. The signal delay shows averaging over the time interval of the selected stage in seconds: Example Stage 10 = average of the readings from the last 10 seconds.



The delay of the signal in relation to the change in the process is also significantly influenced by the selection of the particle filter.

Field	Explanation
Limit values, relay 1 to 4/alarm values, alarm 1 to 4	In this mask, the relays or display alarms are parameterized.

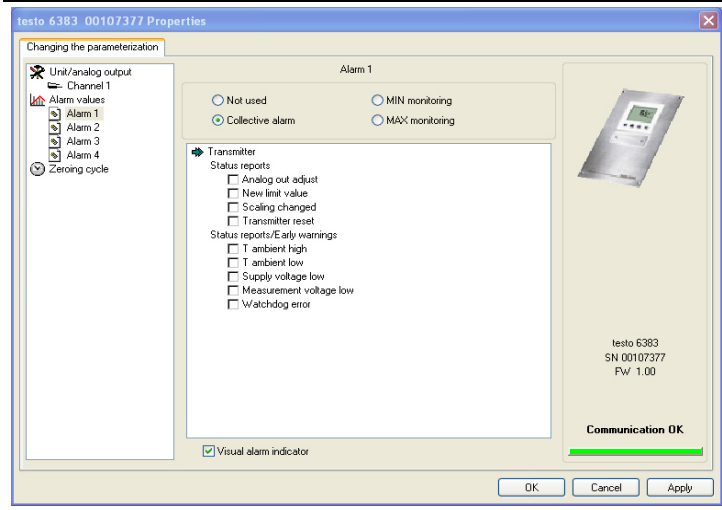

Relay x/alarm x	Four relays or alarm values are available (optional).
Not used	Relay is not used. Hysteresis image and input options are hidden.
Collective alarm	A relay can be used as a collective alarm detector in the event that selected messages appear. Selection of the messages (OR linkage) by selecting the checkbox.
Min control	If switched to ON (NO contact) or OFF (NC contact) under the limit value; in the event of a subsequent exceeding of Limit value plus Hysteresis , it is switched to OFF (NO contact) or ON (NC contact).

Field	Explanation
Max control	If switched to ON (NO contact) or OFF (NC contact) above the limit value; in the event of a subsequent undershooting of Limit value minus Hysteresis , it is switched to OFF (NO contact) or ON (NC contact).

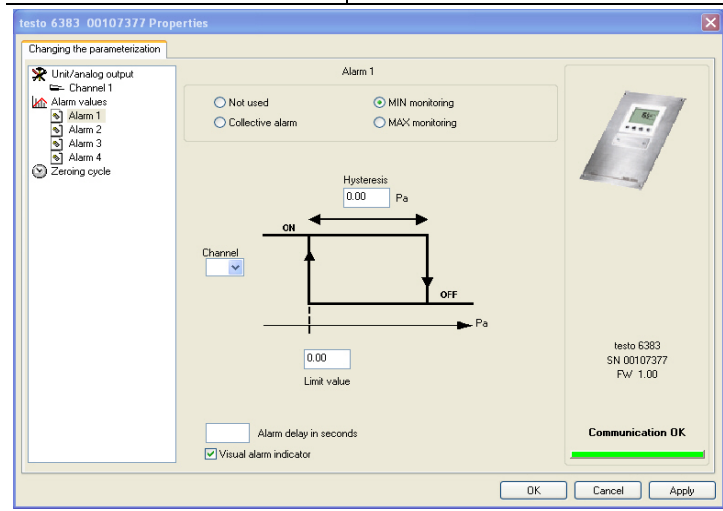

i The graphic display in the centre of the screen refers to the relay wiring as a NO contact (ON).

Hysteresis	To avoid switching cycles.
Channel	Selection of the channel that is to be monitored.
Limit value	Values for the limits of the unit selected in Unit/analog output ; 4 decimal places. When changing the phys. unit, the relay limit values are set to the default values.
Visual alarm display	Checkbox is activated: Upon the appearance of the selected alarm, the background lighting of the display and the corresponding measurement value flashes.

Field	Explanation
Alarm delay	The desired alarm delay for the alarms of the min/max control and the visual alarm is entered in the input field (0 to 3600 seconds possible). The alarm delay has no effect on the collective alarms.

Field	Explanation
Display	Setting the display functions (if a display is available on the transmitter).

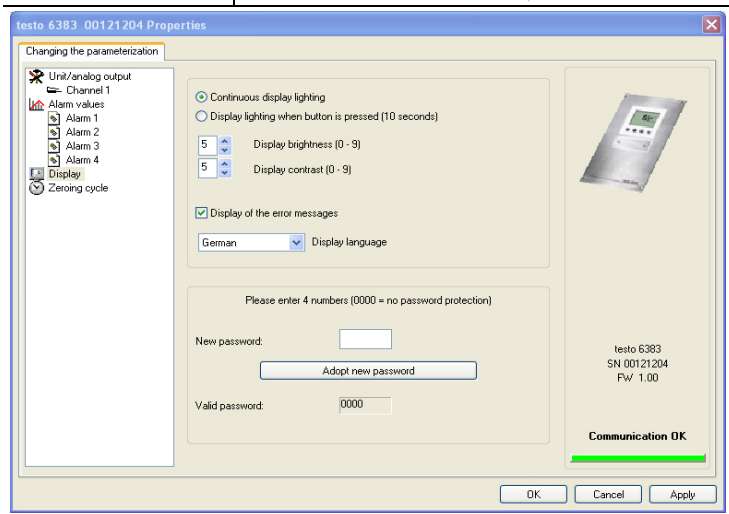

Continuous display lighting	Display lighting is permanently switched on.
Display lighting when button is pressed (10 seconds)	When a particular button on the instrument is pressed, the display lights up for 10 seconds.
Display brightness (0 to 9)	Setting the brightness between 0 and 9: 0 = dark 9 = light
Display contrast (0 to 9)	Setting the contrast between 0 and 9: 0 = low contrast 9 = high contrast

Field	Explanation
Display of the error messages	Selection of whether the error messages should be shown in the display.
Display language	Selection of the language.
New password	The password consists of four numbers, each of which must be between 1 and 9. If the password protection is not to be used, the numerical code "0000" must be entered.
[Adopt new password]	Button for confirming the new password.
Valid password	Display of the current password.

Button	Explanation
Ethernet	Networking the transmitters via Ethernet. For a multitude of applications, measurement data can be simultaneously recorded, documented and visualized.

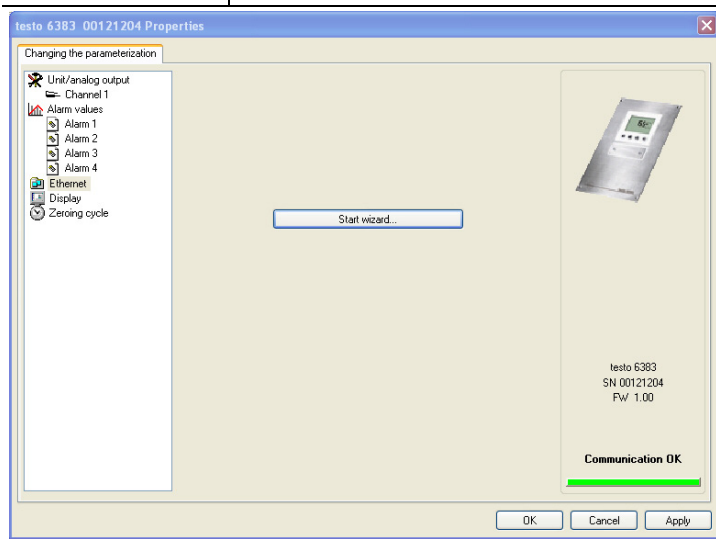

Start wizard...

Address allocation of the testo 6383 with Ethernet module:

Button	Explanation
--------	-------------

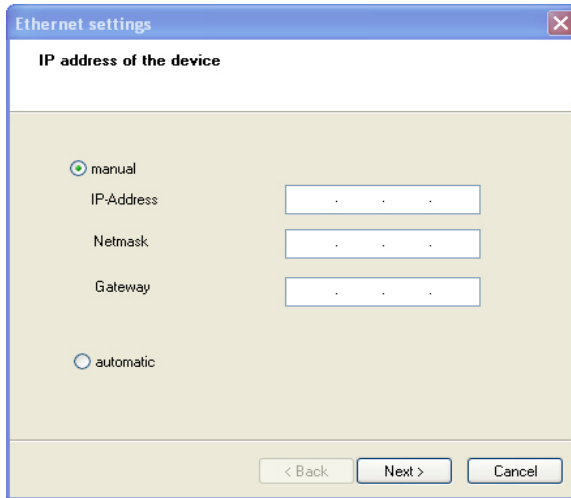

IP address	Transmitter IP address
------------	------------------------



Prior to the automatic allocation of the IP address, the network cable must be connected to the transmitter.

IP address of the device	Address allocation of the testo 6383 with Ethernet module:
Manual	<ul style="list-style-type: none"> • Define the IP address of the transmitter • Enter netmask • Enter gateway
Automatic	Automatic allocation of the IP address

Field	Explanation
Zeroing cycle	Setting the interval of the automatic zeroing with solenoid valve.

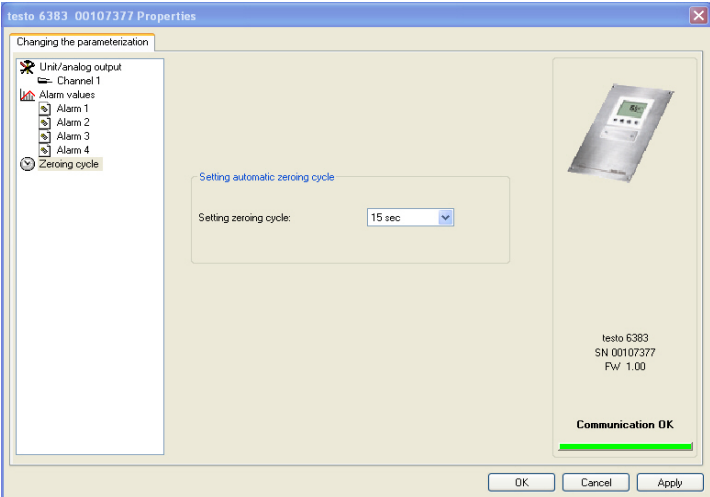
Field	Explanation
	

i The accuracy specifications are only valid for the zeroing cycle of 15 sec set by the factory.

Zeroing cycle setting	Selection of the time interval after which the automatic zeroing cycle is to occur. Recommendation: 15 sec
-----------------------	---

5.3.2.2. Saving parameters

Parameters can be saved in new parameter files.

1. Mark instrument/parameter file.
 2. Click on **File > Save as** in the menu bar.
 3. Select storage location and enter the file name.
 4. Click on **[Save]**.
- The new parameter file is shown in the file list.

Only the parameters are saved from an instrument file; the history data are not adopted.

i The original name (Instrument type, Serial number) is suggested with the current date/time as standard, e.g. "testo 6383 01234578 061120 1403.cfp".

For a standard installation, the files are saved under "C:\Documents and Settings\All Users\Shared Documents\P2A Software". The path can differ depending on the version of the operating system.

5.3.2.3. Opening the parameter file

All parameter files stored in the standard directory path are automatically displayed in the file list when the software is started. You can also open parameter files that are stored in other directories.

1. Click on **File > Open** in the menu bar.
2. Select the storage location and click on the requisite file.
3. Click on **[Open]**.
 - The selected file is opened. This can be changed and saved (see Editing instrument/parameter file page 61).

5.3.2.4. Copying and pasting parameters

The parameters of a parameter file can be transmitted to an instrument file or another parameter file from the same instrument type.

1. Select file from which parameters are to be copied.
2. Click on **Edit > Copy** in the menu bar.
3. Select the file which is to be modified.
4. Click on **Edit > Paste** in the menu bar.
 - The parameters are transmitted to the file.



You can also use the common keyboard shortcuts for copying (CTRL+C) and pasting (CTRL+V).

Parameters can also be transmitted using drag & drop, where you drag the icon of the parameter file onto the icon of the target instrument file.

5. Connect and select corresponding instrument.
6. Click on **[Change parameterization]**.
7. Confirm confirmation request.
 - Parameter data are transferred to the instrument.

5.3.2.5. Deleting instrument/parameter file

Instrument/parameter files can be deleted from the file list.

1. Click on the file that is to be deleted with the right mouse button.
2. Select the command **Delete** in the context menu.
 - The instrument or parameter file is deleted from the list.

5.3.2.6. Creating a new instrument file

It is possible to create an instrument file without restarting the P2A software.

- ✓ Transmitter must be connected.
- 1. Click on **File > New connection** in the menu bar.
- Connection to the transmitter is established.

5.3.3. Analyzing/testing the transmitter

In this section, you can test the outputs of the connected instrument, read off the limit values and reset the parameters to the factory settings.

The function is only available for instrument files.

5.3.3.1. Analyzing/testing the instrument

- ✓ The required instrument file is marked.
- 1. Click on **[Test/analyze transmitter]**.
- The **Properties of <Instrument type> <Serial number>** dialogue is opened with the **Test/analyze transmitter** register.
- 2. Perform action:

Action	Explanation
Carrying out factory reset	Reset the unit, limit value and hysteresis parameters to factory settings (see below).
Testing analog output	Test channel 1 (see 4.4.5.4. Testing functionality of analog outputs).
Test switch outputs	Manually switch relays 1 to 4 to test for proper function (see 4.4.5.4. Testing functionality of relay outputs).
Display min./max. values	Overview of the minimum and maximum values measured since the last reset of the transmitter (see 5.3.3.5. Displaying min./max. values).

- 3. Click on **[OK]** or **[Cancel]** to close the dialogue.

5.3.3.2. Carrying out factory reset

- ✓ The required instrument file is marked.
- 1. Click on **[Test/analyze transmitter]**.
- The **Properties of <Instrument type> <Serial number>** dialogue is opened with the **Test/analyze transmitter** register.
- 2. Mark transmitter test.
- Current operating hours are shown.
- 3. Confirm control query to perform the reset.

- The values are reset to the customer-specific factory settings.
4. Click on **[OK]** or **[Cancel]** to close the dialogue.

5.3.3.3. Testing analog output

- ✓ The required instrument file is marked.
1. Click on **[Test/analyze transmitter]**.
 - The **Properties of <Instrument type> <Serial number>** dialogue is opened with the **Test/analyze transmitter** register.
 2. Mark channel and test values.

Field/button	Explanation
Transmitter test	Check the analog outputs (see 4.4.5.4. Testing functionality of analog outputs).

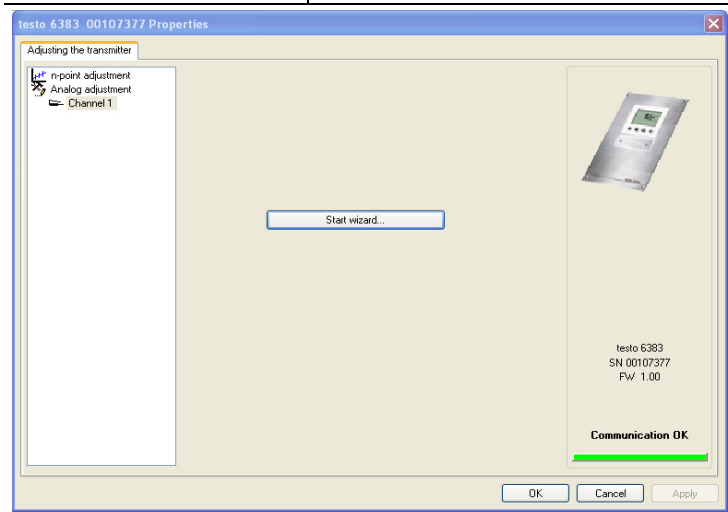

Current reading	Readings are updated every second.
Unit	Unit according to the type of analog output.
Default value	Freely definable output value for the respective type of analog output (V or mA), 1 decimal place.

Field/button	Explanation
[Activate]	<p>The entered default value is forwarded to the corresponding analog output and to the test contacts by clicking. A warning informs that the value is being transmitted to the connected instrument in the event of existing cabling.</p> <p>Now check the analog output using a precise multimeter.</p>
[Deactivate]	<p>Finish entering the electrical variables at the analog output.</p> <p>The analog output returns to the current reading again.</p>

3. Click on **[OK]** or **[Cancel]** to close the dialogue.
 - The analog output and the relay return to Measuring Mode again.

5.3.3.4. Testing switch output relays 1 to 4

- ✓ The required instrument file is marked.
- 1. Click on **[Test/analyze transmitter]**.
 - The **Properties of <Instrument type> <Serial number>** dialogue is opened with the **Test/analyze transmitter** register.

2. Mark **Relay tests** and test the values.

Field/button	Explanation
	Test the relay function (see 4.4.5.4. Testing functionality of relay outputs).

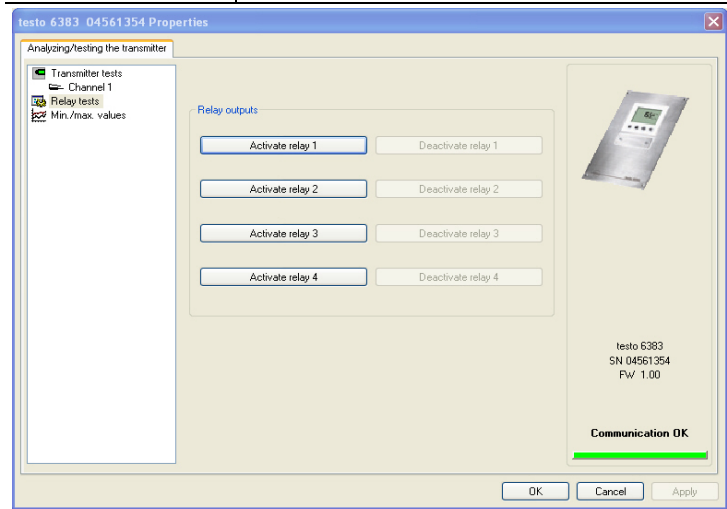

[Activate relay n]	Close contact. A warning informs that the value is being transmitted to a connected PLC, external display, etc. in the event of existing cabling.
[Deactivate relay n]	Open contact. A warning informs that the value is being transmitted to a connected PLC, external display, etc. in the event of existing cabling.

3. Click on **[OK]** or **[Cancel]** to close the dialogue.
- The analog output returns to Measuring Mode again.

5.3.3.5. Displaying min./max. values

The transmitter saves the minimum or maximum value for each channel (measured since the last voltage supply or since the last manual reset).

- ✓ The required instrument file is marked.
1. Click on [Test/analyze transmitter].
- The **Properties of <Instrument type> <Serial number>** dialogue is opened with the **Test/analyze transmitter** register.

2. Mark **Min./max. values**.

Field/button	Explanation
Min./max. values	View the min./max. values of each channel. Only the values within the measuring range are shown.

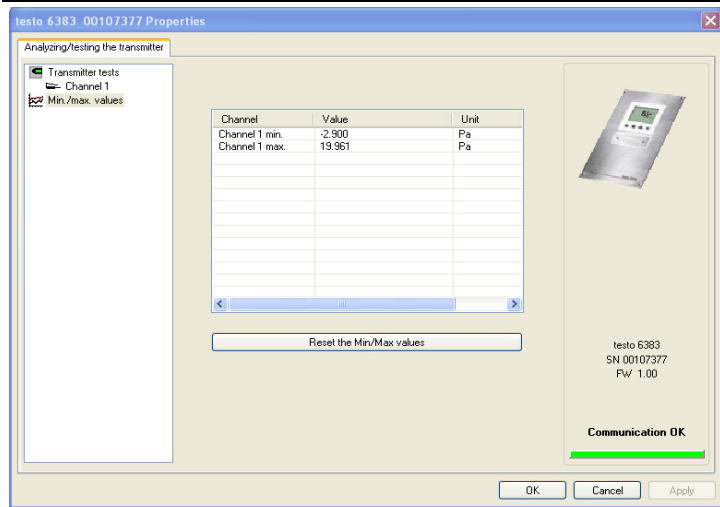

Channel	Channel 1 min./max.
Value	Min. or max. value, 1 decimal place.
Unit	Unit selected in Unit/analog output .

3. Reset **Min./max. values**.
4. Click on **[Reset min./max. values]**.
5. Confirm control query to perform the reset.
 - The values are reset to the factory settings.
6. Click on **[OK]** or **[Cancel]** to close the dialogue.

5.3.4. Adjusting the transmitter

This function is used to adjust an attached instrument. The following adjustments may be carried out using the software:

- Analog adjustment (entry via assistant/wizard)
- n-point adjustment (entry via assistant/wizard)

Also see 4.4.5.7. Editing Main Menu Adjust.

5.3.4.1. n-point adjustment

1. Connect precision pressure sensor (see 4.3.5.2. n-point adjustment).
2. Mark the instrument file of the connected instrument.
3. Click on **[Adjusting the transmitter]**.
 - The **Properties of <Instrument type> <Serial number>** dialogue is opened with the **Adjusting the transmitter** register.
4. Mark **n-point adjustment**.
5. Click on **[Start wizard ...]** and follow the instructions of the wizard.
 - The adjustment is performed when the wizard is closed.

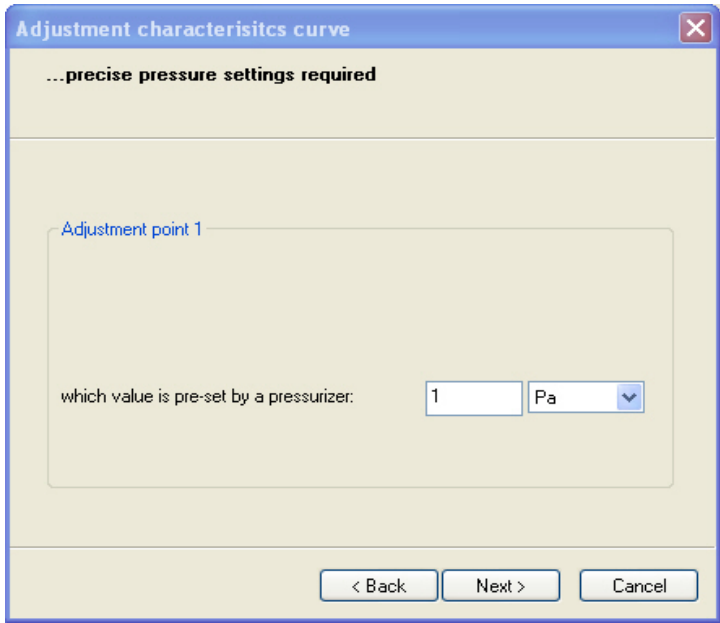
Field	Explanation
	

How much pressure is actually applied	Required field: Entry of the value read off at the pressure sensor.
---------------------------------------	---

i The n-point adjustment must always be carried out to its full extent and in good time at all selected adjustment points.

i The number of adjustment points (3 to 6) is stored in the user menu of the transmitter and can only be changed via the P2A software.

5.3.4.2. Adjusting the analog output

1. Connect precision multimeter.
2. Mark the instrument file of the connected instrument.
3. Click on **[Adjusting the transmitter]**.
 - The **Properties of <Instrument type> <Serial number>** dialogue is opened with the **Adjusting the transmitter** register.
4. Click on **[Start wizard ...]** and follow the instructions of the wizard.
 - The adjustment is performed when the wizard is closed.

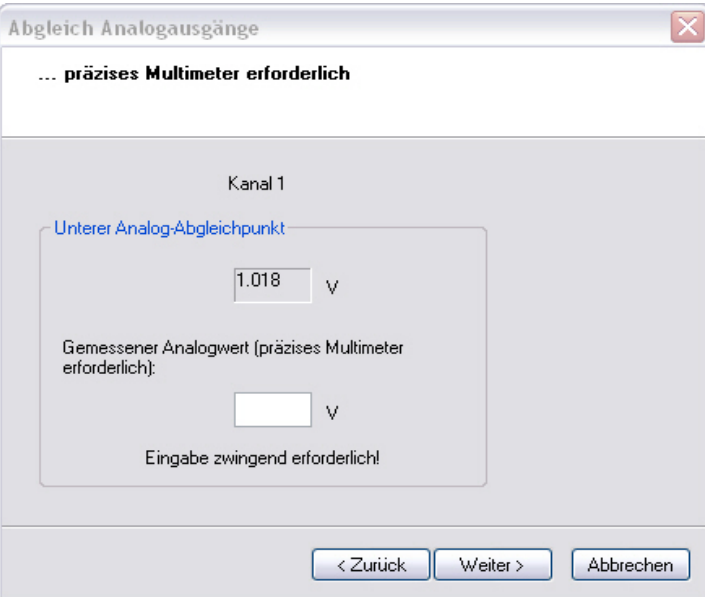
Field	Explanation
	

Default value

The analog output value from the last performed adjustment is given at the output. Value of the factory adjustment:

- Lower adjustment point: approx. 10 % of the max. value
- Centre adjustment point: approx. 50 % of the max. value
- Upper adjustment point: approx. 90 % of the max. value

Field	Explanation
Measured analog value	Required field: Entry of the value read off at the multimeter.

5.3.5. Transmitter history

Parameterizations, adjustment processes and messages that have occurred are registered in the transmitter with an operating hours stamp.

In the history overviews (explained later in more detail), past processes and events can be made visible.



For parameter changes or adjustments that are performed directly at the instrument (via the user menu), "Transmitter" is entered in the **User** field and only the operating hour is entered in the **Date/time** field instead of operating hour/date/time.

For entries that are performed using the P2A software, the name of the user logged into Windows appears in the **User** field, while the date/time and operating hour are shown in the **Date/time** field.

-
1. Mark the instrument file of the connected instrument.
 2. Click on the **[Transmitter history]** button.
 - The **Properties of <Instrument type> <Serial number>** dialogue is opened with the **Transmitter history** register.

3. Click on the required entry in the list to change the display.

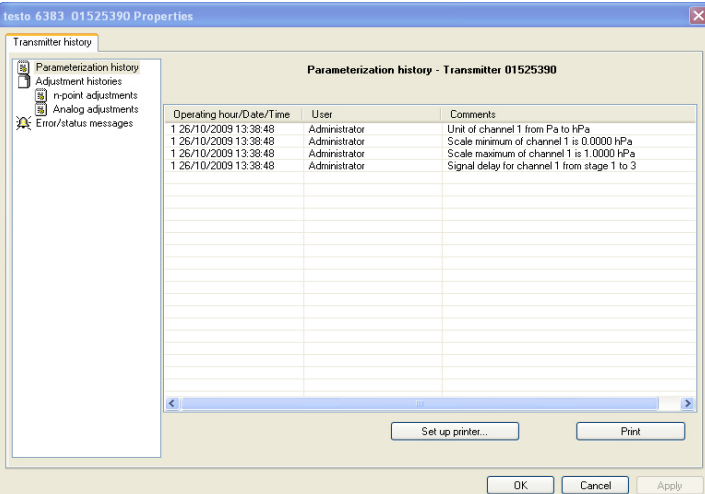
Field	Explanation
	
Operating hours / date/time	Operating hour/time stamp at which the change at the instrument was performed.
User	Name with which the user is logged into the operating system. "Transmitter" entry if the change was performed at the instrument.
Comments	Type of parameter change, e.g. "Unit of channel 1 from Pa to bar".

Field	Explanation
Operating hours / date/time	Operating hour/time stamp at which the change at the instrument was performed.
User	Name with which the user is logged into the operating system. "Transmitter" entry if the change was performed at the instrument.
Unit	Unit during the adjustment.
Channel	Analog adjustment: Channel 1 to n.
Specification	Analog adjustment: Actual value.
Pressure specification	n-point adjustment: Reference value set at the pressure sensor.
Multimeter	Analog adjustment: Reference value set at the multimeter.
Offset	Analog adjustment: Deviation at time of adjustment.

Selection: **Analog adjustments.**

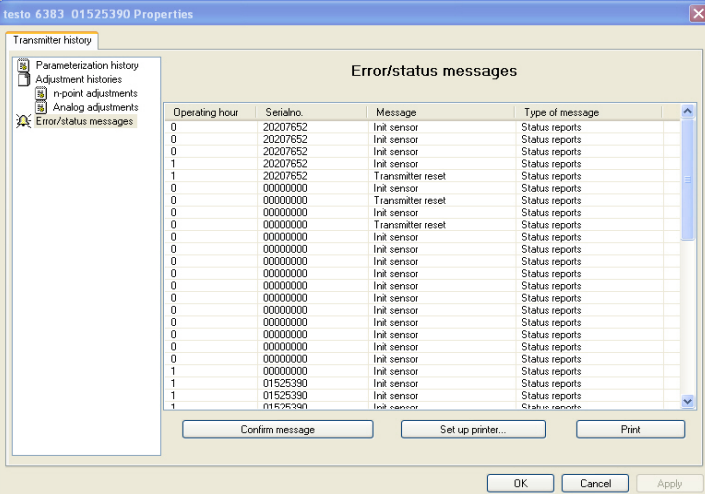
Field	Explanation
	

The table is shown only for error and status messages that were generated in the transmitter and were transferred and saved there via the connection to the P2A software.

Operating hour	Operating hour at which the message appeared in the instrument.
Message	e.g. "Watchdog error". Due to a processor error, the transmitter performs an automatic restart.
Type of message	e.g. early warning, status message.

> To print out the history data, click on **[Print]**.



The printing job is automatically sent to the default printer for the operating system.

The printout can be edited using **[Set up printer ...]**.

4. Click on **[OK]** or **[Cancel]** to close the dialogue.

6 Tips and assistance

6.1. Questions and answers

Question	Possible causes/solution
Connection to instrument cannot be established	Check connection cable/plug contacts
A message appears on the display	See 4.5. Status, warning and error messages
Malfunction (with and without display)	Analysis using the P2A software, see 5.3.3. Analyzing/testing the transmitter
When does a stable current reading appear?	After approx. 20 seconds

If we could not answer your question, please contact your dealer or Testo Customer Service. For contact details see the rear side of this document or the web page www.testo.com/service-contact

6.2. Accessories and spare parts

Description	Article no.
Spare parts	
Sealing frame	0554 6383
Interface and software	
P2A software (parameterizing, adjusting, analyzing) incl. USB adapter	0554 6020
Hoses	
Silicone hose ID 4 transparent	0086 0001, sold by the metre
TYGON hose ID 4.8 transparent	0086 0031, sold by the metre
Silicone hose transparent, internal diameter 2 mm, for test pressure connections 6383	0086 0003, sold by the metre
Supply	
Mains unit (desktop, wall-mounted)	0554 1748
Mains unit (top-hat rail mounting)	0554 1749
External display	

Description	Article no.
Spare parts	
Sealing frame	0554 6383
Process display for testo 54-2 AC....	5400 7553
Process display for testo 54-7 AC....	5400 7555
Calibration	
Standard ISO calibration certificate, transmitter only	0520 1000
Standard DAkkS calibration certificate, transmitter only	0520 1200

For a complete list of all accessories and spare parts, please refer to the product catalogues and brochures or look up our website at: www.testo.com

6.2.1. Ordering options for testo 6383 transmitter (0555 6383)

Order code	Characteristic
Axx Measuring range	
A01	0 to 50 Pa
A02	0 to 50 Pa
A03	0 to 100 Pa
A04	0 to 500 Pa
A05	0 to 10 hPa
A21	-10 to 10 Pa
A22	-50 to 50 Pa
A23	-100 to 100 Pa
A24	-500 to 500 Pa
A25	-10 to 10 hPa
Bxx Analog output/supply	
B02	0 to 1 V (4-wire, 24 V AC/DC)
B03	0 to 5 V (4-wire, 24 V AC/DC)
B04	0 to 10 V (4-wire, 24 V AC/DC)

Order code	Characteristic
B05	0 to 20 mA (4-wire, 24 V AC/DC)
B06	4 to 20 mA (4-wire, 24 V AC/DC)
Cxx Display	
C00	Without display
C02	With display/English
C03	With display/German
C04	With display/French
C05	With display/Spanish
C06	With display/Italian
C07	With display/Japanese
C08	With display/Swedish
Dxx Integrated humidity probe	
D00	No humidity/temperature probe
D04	Humidity/temperature probe integrated in panel
D05	Preparation for external humidity/temperature probe testo 6610 probe
Exx Ethernet	
E00	Without Ethernet interface
E01	With Ethernet interface
Fxx Differential pressure unit⁷	
F01	Pa/Min/Max
F02	hPa/Min/Max
F03	kPa/Min/Max
F04	mbar/Min/Max
F05	bar/Min/Max
F06	mmH ₂ O /Min/Max

⁷ Scaling +/- 50% of measuring range possible

Order code	Characteristic
F07	inchH ₂ O /Min/Max
F08	inch HG/Min/Max
F09	kg/cm ² /Min/Max
F10	PSI/Min/Max
Gxx Optional analog output for humidity probe connection testo 6610/units⁸	
G01	% RH/Min/Max
G02	°C/Min/Max
G03	°F/Min/Max
G04	°C _{td} /Min/Max
G05	°F _{td} /Min/Max
G06	g/kg /Min/Max
G07	gr/lb /Min/Max
G08	g/m ³ /Min/Max
G09	gr/ft ³ /Min/Max
G10	ppmV/Min/Max
G11	°C _{wb} /Min/Max
G12	°F _{wb} /Min/Max
G13	kJ/kg /Min/Max (enthalpy)
G14	mbar/Min/Max (water vapour partial pressure)
G15	inch H ₂ O/Min/Max (water vapour partial pressure)
G16	°C _{tm} (dewpoint for H ₂ O ₂ mixture)
G17	°F _{tm} (dewpoint for H ₂ O ₂ mixture)
G18	% vol
Hxx Relay	
H00	Without relay

⁸ Only if D04 or D05 is selected

Order code	Characteristic
H01	4 relay outputs, limit value monitoring
H02	4 relay outputs, channel 1 limit values and collective alarm
lxx Units, channel 3 (only if optional humidity probe connection is available)⁹	
I01	% RH/Min/Max
I02	°C/Min/Max
I03	°F/Min/Max
I04	°C _{td} /Min/Max
I05	°F _{td} /Min/Max
I06	g/kg /Min/Max
I07	gr/lb /Min/Max
I08	g/m ³ /Min/Max
I09	gr/ft ³ /Min/Max
I10	ppmV/Min/Max
I11	°C _{wb} /Min/Max
I12	°F _{wb} /Min/Max
I13	kJ/kg /Min/Max (enthalpy)
I14	mbar/Min/Max (water vapour partial pressure)
I15	inch H ₂ O/Min/Max (water vapour partial pressure)
I16	°C _{tm} (dewpoint for H ₂ O ₂ mixture)
I17	°F _{tm} (dewpoint for H ₂ O ₂ mixture)
I18	% vol
I19	%RH _m (mixture humidityfor H ₂ O ₂)

⁹ Only if D04 or D05 is selected

